

**CRAFTOP**®



# Owner's Manual

## Chain Saw

**NT4560, NT5260, NT5860, NT6020**



**EXPERTS  
IN EQUIPMENTS OF  
GARDENING AND AGRICULTURE**

**ENGLISH  
VERSION: 01-202106**

## **We thank you for buying CRAFTOP Chain Saw**

This chain saw provides advanced technology in incorporating many convenient features for you to perform your daily cutting work.

**Before attempting to use this chain saw, please read this manual carefully until you completely understand and can follow all safety rules, precautions, operating and maintenance instructions.** It will help you both to become more familiar with this chain saw and to recognize and avoid situations that could endanger you and others. **Careless or improper use may cause serious or even fatal injury!**

If you have any question about your chain saw and this manual, please contact CRAFTOP authorized dealer or service center for your area. They always welcome your questions, suggestions, and constructive criticism.

We hope you enjoy this chain saw and wish you many years of safe and enjoyable cutting work.

**CRAFTOP CANADA LTD.**

## Table of contents

Guide to use this manual .....	1
Product overview.....	3
Technical specification .....	3
Safety features .....	5
Cutting equipments .....	8
Safety precautions and instructions .....	10
Assembly.....	18
Fuel and fueling.....	20
Chain lubricant .....	21
Start and stop the engine .....	22
Operation.....	25
Working techniques.....	26
Maintenance and care.....	34
Storage.....	48
Disposal.....	48
Troubleshooting guide.....	49

## Guide to use this manual

This Owner's Manual refers to a CRAFTOP chain saw, also called a machine in this Owner's Manual.

All information, specifications, descriptions and illustrations in this manual are as accurate as known at the time of publication, but are subject to change without notice. Due to ongoing product development, there may be difference between your machine and the information in this manual. No legal obligations or commitments can be delivered from the information, specifications, descriptions, or illustrations in this manual.

Illustrations are only for orientation and are merely used to help explain the text descriptions and instructions. Illustrations may include optional equipment and accessories, and may not include all standard equipment.

Some signs or symbols on the machine may be a little different refer to special certification requirements for certain markets.

Any technical modifications to the machine that were introduced after the editorial deadline please consult your local dealer for more supplementary information.

All safety precautions and instructions described in this manual should be observed during operation of the chain saw, and all applicable federal, state and local safety regulations, standards, and ordinances should be observed as well.

Do not sell, lend or rent the machine without this owner's manual. Always be sure to include this owner's manual together with the machine, and make sure that anyone using it understands all the information and follows all the instruction contained in this manual.

## Signs and symbols in this manual

### **DANGER**

Texts with this symbol contain information regarding hazardous situations which will cause death or severe injures if not avoided.

### **WARNING**

Texts with this symbol contain information regarding hazardous situations which could cause death or severe injures if not avoided.

### **CAUTION**

Texts with this symbol contain information regarding hazardous situations which could cause minor or moderate injures if not avoided.

### **NOTICE**

Texts with this symbol information regarding situation which could cause chain saw damage if not avoided.

### **information**

Texts with this symbol contain supplementary information.

### **Read and understand the Owner's Manual.**



It is very important that you read this Owner's Manual carefully, make sure that you completely understand and can follow all safety rules, precautions, operating and maintenance instructions before attempting to use this chain saw, failure to do so may cause serious or even fatal injury!



Special safety precautions must be observed to reduce personal injury because it is a high-speed wood-cutting tool with very sharp edges.



### **Wear proper clothing.**



### **Wear eye, ear and head protection.**

Always wear appropriate personal protective equipments for chain saw operation, inclusive of eye protection, ear protection, and head protection.



### **Face mask required.**

Operators who are sensitive to dust or other common airborne allergens may need to wear a dust mask.



**Hands protection.**

Always wear appropriate gloves for chain saw operation.



**Foot protection required.**

Steel toe shoes with anti-slip sole required in working area.



**Fire hazard.**

Risk of fire.  
Highly flammable material.



**No smoking.**

Do not smoke in this area.



**Sharp edges.**

**Watch you fingers.**

Do not touch the saw chain while the engine is running.



**Hot surface.**

Do not touch.

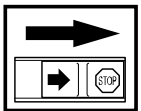

Switch off the engine by moving the stop switch to the STOP position before carrying out any checks or maintenance.

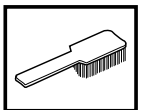

Regular cleaning is required.

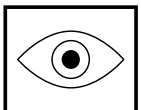

Visual check.



Protective glasses or a visor must be worn.



**CAUTION!** Chain saws can be dangerous! Careless or incorrect use can result in serious or fatal injury to the operator or others.



Please read the instructions carefully and make sure you understand them before using the saw.



Always wear:

- Approved protective helmet
- Approved hearing protection
- Protective glasses or visor



This product is in accordance with applicable CE directives.



Fuel tank;

Fuel mixture of gasoline and engine oil.

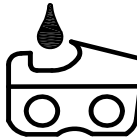

Chain oil tank.

This symbols shows the port to refill chain oil tank, it is located on the cap of chain oil tank.

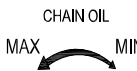

Chain oil flow adjusting nut.

To reduce the oil flow, turn nut to MIN direction.

To increase the oil flow, turn nut to MAX direction.



Engaging or disengaging the chain brake.

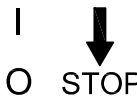

Engine stop switch.

Stop the engine by flipping the switch to O position.



**Carburetor adjustment.**

-High speed mixture.



**Carburetor adjustment.**

-Low speed mixture.



**Carburetor adjustment.**

-Idle speed mixture.

**Signs and symbols on the machine**

For the purpose of safety operation and maintenance, the meanings of signs and symbols may be attached to or embossed on the machine.

Other signs or decals on the machine refer to special certification requirements for certain markets.

## Product overview

### General overview

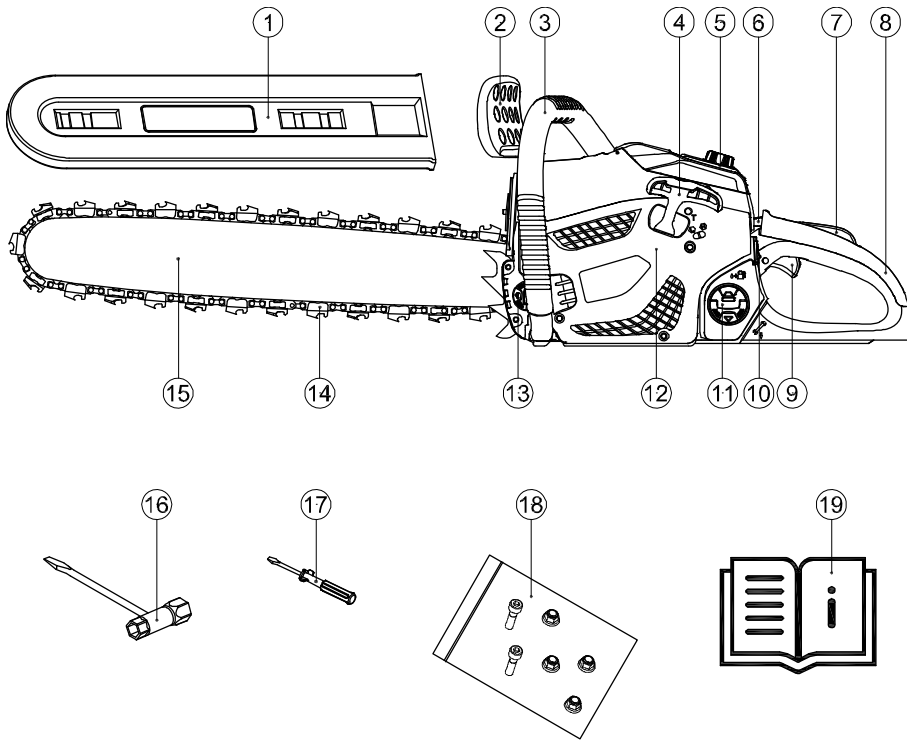



- |   |                            |    |                      |    |                    |
|---|----------------------------|----|----------------------|----|--------------------|
| 1 | Bar/Chain Guard (Scabbard) | 8  | Rear Handle          | 15 | Guide bar          |
| 2 | Front Hand Guard           | 9  | Throttle Control     | 16 | Combination wrench |
| 3 | Front Handle               | 10 | Engine Stop Switch   | 17 | Screwdriver        |
| 4 | Recoil Starter Handle      | 11 | Fuel Tank            | 18 | Fasteners          |
| 5 | Cylinder Cover             | 12 | Recoil Starter Cover | 19 | Owner's Manual     |
| 6 | Choke Control              | 13 | Chain Oil Tank       |    |                    |
| 7 | Throttle Lock              | 14 | Saw Chain            |    |                    |

## Technical specification

MODEL			NT4560	NT5260	NT5860	NT6020
Item	Description	Unit	Specification			
Overall	Dimension (without guide bar and chain)	in mm	19x10x12 480x260x300	20x10x12 510x260x300	17x10x12 440x260x300	22x10x12 550x260x300
	Weight (without guide bar and chain)	lbs/kg	11.7/5.3	11.7/5.3	11.7/5.3	12.1/5.5
Engine	Type		Home use			
	Displacement	cc	45	49.3	54.5	55.6
	Engine stroke type		2 stroke			

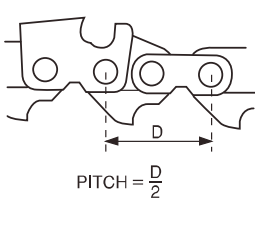
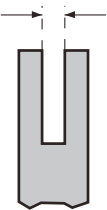
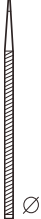
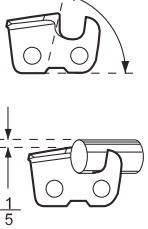
MODEL			NT4560	NT5260	NT5860	NT6020
Item	Description	Unit	Specification			
	Power	kw/hp/rpm	1.8/2.4/8,000	2/2.72/8,000	12.2/3/8,000	2.7/3.6/8,500
	Carburetor		CRAFTOP			
	Starter		Manual			
	Engine speed, Idle	rpm	3,200±200			
	Engine speed -clutch engagement	rpm	4,000~4,600			
	Engine speed, -wide open throttle	rpm	11,500 (without guide bar and chain)			
Ignition system	Type		CDI			
	Spark plug		L7T			
	Electrode gap	mm	0.35-0.50			
Fuel system	Mixed ratio		40:1 (Gasoline : Oil)			
	Gasoline		Minimum 90#			
	Oil		CRAFTOP OIL			
	Tank capacity	ml	590			
Chain lubrication	Lubrication oil type		CRAFTOP CHAIN OIL			
	Tank capacity	ml	260			
Guide bar	Type		Alloy			
	Sprocket		Pitch 0.325inch-7 teeth, Pitch 3/8inch-6 teeth			
	Standard bar length	in	18	20	22	24
	Maximum cutting length	mm	450	500	550	610
	Recommended bar length	in	18	20	22	24
	Groove width	mm	1.5~1.65 / 1.65~1.8			
	Pitch	in	NA			
	Gauge	in	0.058 / 0.063			
Noise levels	Equivalent noise pressure level	dB(A)	110dB ( A )			
	Equivalent noise power level	dB(A)	110(LWA)dB(A)			
Vibration levels	Front handle	m/s <sup>2</sup>	Average 34.6			
	Rear handle	m/s <sup>2</sup>	Average 35.3			

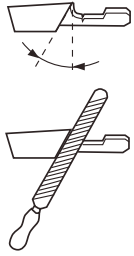
			
0.325" / 0.375" 8.3mm / 9.6mm	1.5mm~1.65mm 1.65mm~1.8mm	13/64" 5.2mm	60°

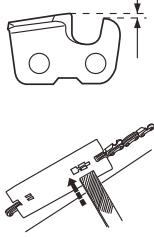
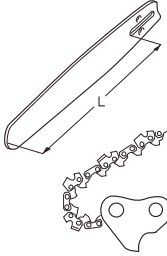
			
30°	10°	0.058" / 0.063" 1.5mm / 1.6mm	18", 20", 22", 24"

**i information**  
 Specifications, descriptions and illustrations in this manual are as accurate as known at the time of publication, but are subject to change without notice.

## Safety features

### Chain brake and front hand guard

Our chain saw is equipped with a chain brake that is designed to stop the chain immediately if you get a kickback. The chain brake can reduce the risk of accidents, but only you can prevent it. Do not assume that the chain brake itself will protect you in the event of a kickback.

**! WARNING**  
 Take care and make sure the kickback zone of the chain bar never touches any object when using your chain saw.

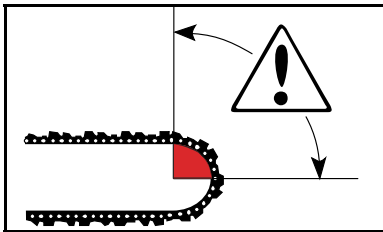

The chain brake (A) can either be activated manually (by your left hand) or automatically by the inertia release mechanism (a free- swinging pendulum). On most of our models the front hand guard acts as a counterweight in case of kickback.

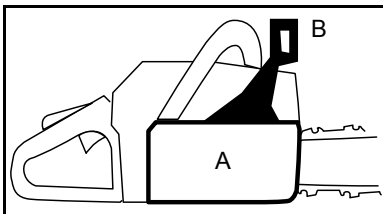

The brake is applied when the front hand guard (B) is pushed forwards.

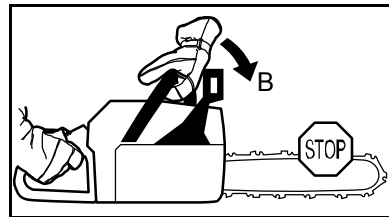

This movement activates a spring-loaded mechanism that tightens the Brake Band (C) around the engine drive system (D) (Clutch Drum).

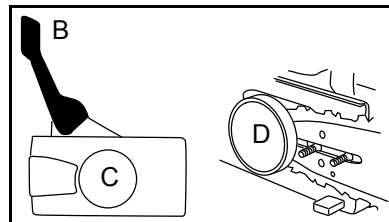

The front hand guard is not designed solely to activate the chain brake. Another important safety feature is that it prevents the chain from hitting your left hand if you lose your grip on the front handle.

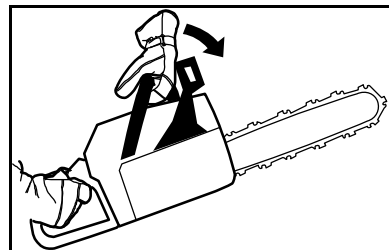

You can also use the chain brake as a temporary brake when you change position or if you put the saw down for a short time. You should also apply the chain brake manually if there is a risk of the chain accidentally hitting anyone or anything close by.

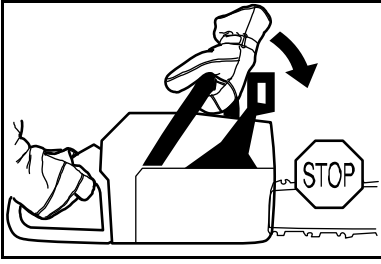

To release the chain brake pull the front hand guard backwards, towards the front handle.

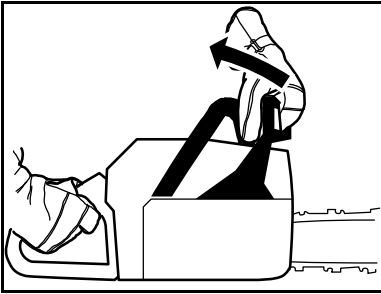

The inertia activated chain brake increases your safety, but there are certain factors to remember. The way the chain brake is triggered, either manually or automatically, depends on the force of the kickback and the position of the chain saw in relation to the object that the kickback zone of the bar strikes.

If you get a violent kickback while the kickback zone of the bar is farthest away from you the chain brake will be activated by the movement of the counterweight (INERTIA ACTIVATED).

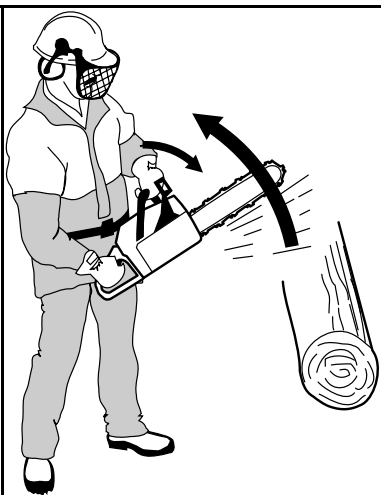

If the kickback is less violent or the kickback zone of the bar is closer to you the chain brake will be activated manually by the movement of your left hand.

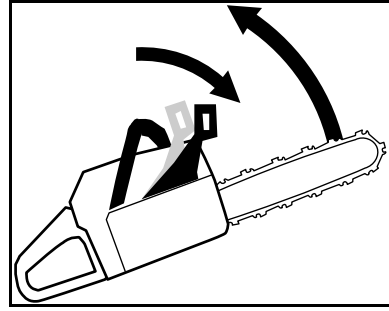

During felling your left hand grasps the front handle in such a way that it cannot activate the front hand guard. In this position the chain brake can only be activated by the inertia action of the counterweight.



### Throttle lock

The throttle lock is designed to prevent accidental operation of the throttle control. When you press the lock (A) (i.e. when you grasp the handle) it releases the throttle trigger (B).

When you release the handle the throttle trigger and the throttle lock both move back to their original positions. This movement is controlled by two independent return springs.

This arrangement means that the throttle control is automatically locked at the idle setting when you release the handle.

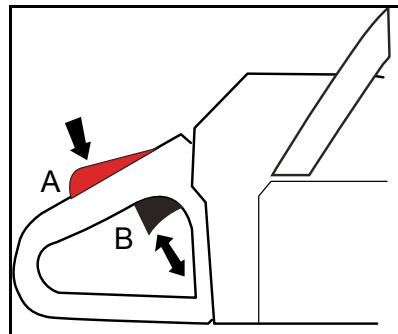



## Chain catcher

The chain catcher is designed to catch the chain if it snaps or jumps off. This should not happen if the chain is properly tensioned and if the bar and chain are properly serviced and maintained.

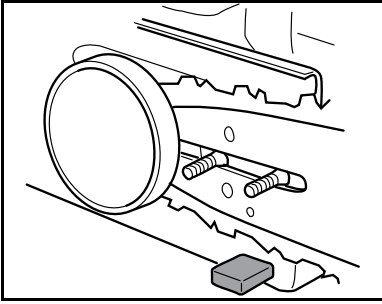

## Right hand guard

Apart from protecting your hand if the chain jumps or snaps, the right hand guard stops branches and twigs from interfering with your grip on the rear handle.

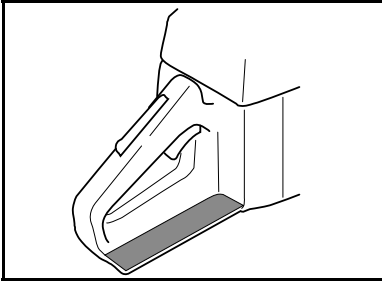

## Vibration damping system

Your chain saw is equipped with a vibration damping system that is designed to minimize vibrations and make operation more comfortable and easier to work with this machine.

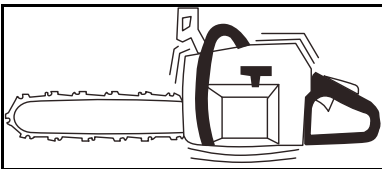

When you use a chain saw vibrations are generated by the uneven contact between the chain and the wood you are cutting.

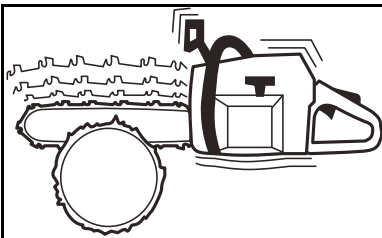

Cutting hardwoods (most broadleaf trees) creates more vibration than cutting softwoods (most conifers). Cutting

with a chain that is blunt or faulty (wrong type or badly sharpened) will increase the vibration level.

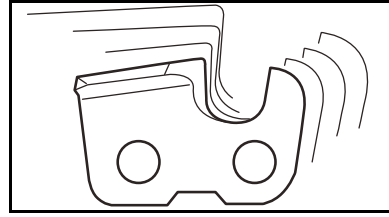

The vibration damping system reduces the vibrations transmitted from the engine and chain to the handles of the chain saw. The body of the saw, including the cutting equipment, is insulated from the handles by vibration damping units.

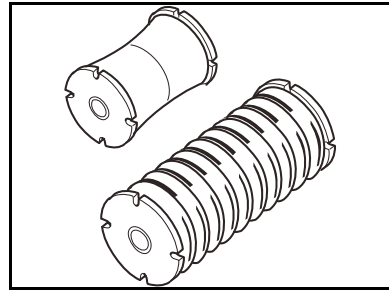

## WARNING

Exposure to vibrations through prolonged use of gasoline powered hand tools could cause blood vessel or nerve damage in the fingers, hands, and joints of people prone to circulation disorders or abnormal swellings. Prolonged use in cold weather has been linked to blood vessel damage in otherwise healthy people. If symptoms occur such as numbness, pain, loss of strength, change in skin color or texture, or loss of feeling in the fingers, hands, or joints, stop the use of this machine and contact your doctor immediately. An anti-vibration system does not guarantee the avoidance of these problems. Owners who operate power tools on a continual and regular basis must monitor closely their physical condition and the condition of this tool.

## Stop switch

Use the stop switch to shut off the engine.

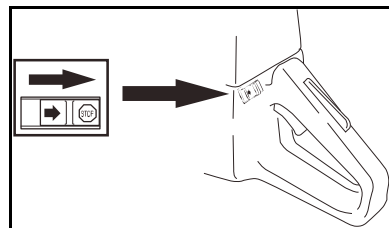

## Muffler

The muffler is designed to keep noise levels to a minimum and to direct exhaust fumes away from the operator.

## WARNING

The exhaust fumes from the engine are hot and may contain sparks which can start a fire. Never start the saw indoors or near combustible material!

In areas with a hot, dry climate there is a high risk of forest fires. These areas are sometimes controlled by legislation and requirements that among other things the muffler (A) must be equipped with an approved type of spark arrestor mesh (B).

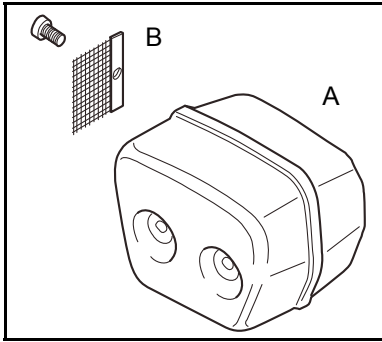

**WARNING**  
The muffler gets very hot in use and remains so for a short time afterwards. Do not touch the muffler if it is hot!

### Kickback safety features

**WARNING**  
The following features are included on your saw to help reduce the hazard of kickback; however, such features will not totally eliminate this danger. As a chain saw owner, do not rely only on safety devices. You must follow all safety precautions, instructions, and maintenance in this manual to help avoid kickback and other reactive forces which can result in serious or even fatal injury.

- Reduced-Kickback Guide Bar, designed with a small radius tip which reduces the size of the kickback danger zone on the bar tip. A Reduced-Kickback Guide Bar has been demonstrated to significantly reduce the number and seriousness of kickbacks.

- Reduced Kickback Symmetrical Guide Bar

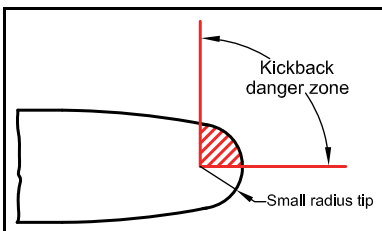

- Symmetrical Guide Bar

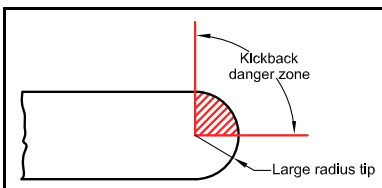

- Front Hand Guard, designed to reduce the chance of your left hand contacting the chain if your hand slips off the front handlebar.
- Position of front and rear handlebars, designed with distance between handles and in-line with each other. The spread and in-line position of the hands provided by this design work together to give balance and resistance in controlling the pivot of the saw back toward the operator if kickback occurs.

**WARNING**  
Do not rely upon any of the devices built into your chain saw, you should use the machine properly and carefully to avoid kickback.

Reduced-kickback guide bars and low-kickback saw chain reduce the chance and magnitude of kickback and are recommended. Repairs on a chain brake should be made by authorized dealer or service center. Take your machine to the place of purchase if purchased from an authorized dealer, or to the nearest authorized service center.

- Tip contact in some cases may cause a lightning fast reverse REACTION, kicking the guide bar up and back toward the operator.
- Pinching the saw chain along the top of the guide bar may push the guide bar rapidly back toward the operator.
- Either of these reactions may cause you to lose control of the chain saw which could result in serious injury. Do not rely exclusively upon the safety devices built into your chain saw.
- Chain Brake, designed to stop the chain in the event of kickback.

### Cutting equipments

This section describes how to choose and maintain your cutting equipments in order to:

- Reduce the risk of kickback.
- Reduce the risk of the chain breaking or jumping.
- Obtain maximum cutting performance.
- Extend the life of cutting equipment.

### 5 basic rules

1. Only use cutting equipment recommended by us! Detail see the section of technical specification.

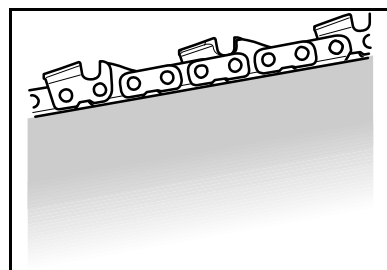

- Keep the chain cutting teeth properly sharpened! Follow our instructions and use the recommended file gauge. A damaged or badly sharpened chain increases the risk of accidents.

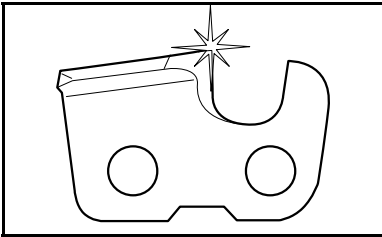

- Maintain the correct raker clearance! Follow our instructions and use the recommended raker gauge. Too large clearance increases the risk of kickback.

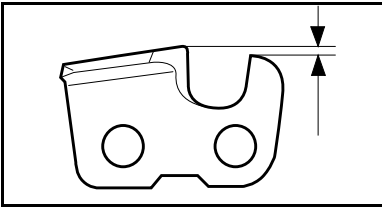

- Keep the chain properly tensioned! If the chain is slack it is more likely to jump off and lead to increased wear on the bar, chain and drive sprocket.

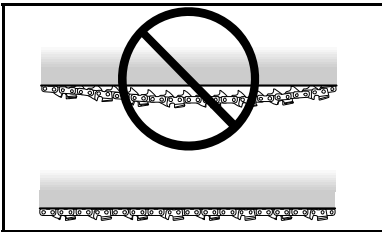

- Keep cutting equipment well lubricated and properly maintained! A poorly lubricated chain is more likely to break and lead to increased wear on the bar, chain and drive sprocket.

## Cutting equipments designed to minimize kickback

**WARNING**  
 Faulty cutting equipment or the wrong combination of bar and chain increases the risk of kickback. Use only the bar and chain combinations recommended in the section of *Technical specification*.

The only way to avoid kickback is to make sure that the kick-back zone of the bar never touches anything. By using cutting equipment with "built-in" kickback protection and keeping the chain sharp and well-maintained you can reduce the effects of kickback.

### A. Bar

The smaller the tip radius the smaller the kickback zone and the lower the chance of kickback.

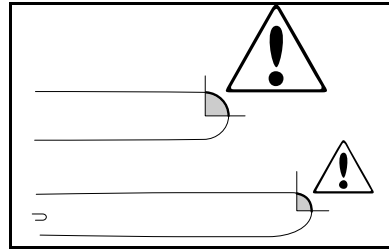

### B. Saw chain

A saw chain is made up of a number of links, which are available in standard and low-kickback versions.

	None	Standard	Low-kickback
CUTTING LINK			
DRIVE LINK			
SIDE LINK			

Combining these links in different ways gives different degrees of kickback reduction. In terms of kickback reduction alone, four different types of link are available.

Kickback reduction	Cutting link	Drive link	Side link
LOW			
STANDARD			
HIGH			
EXTRA HIGH			

### C. Some terms that describe the bar and chain

When the cutting equipment supplied with your saw becomes worn or damaged you will need to replace it. Use only the type of bar and chain recommended in the section of *Technical specification*.

#### • Bar

- LENGTH (inches/cm).

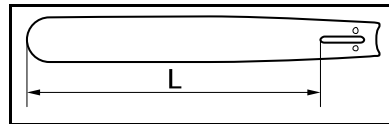

- NUMBER OF TEETH ON BAR TIP SPROCKET (T).. Small number = small tip radius = low-kickback

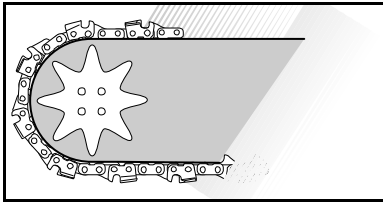

- **CHAIN PITCH** (inches). The spacing between the drive links of the chain must match the spacing of the teeth on the bar tip sprocket and drive sprocket.  $PITCH=D/2$ .

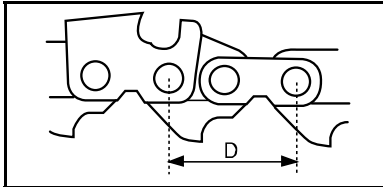

- **NUMBER OF DRIVE LINKS** The number of drive links is determined by the length of the bar, the chain pitch and the number of teeth on the bar tip sprocket.

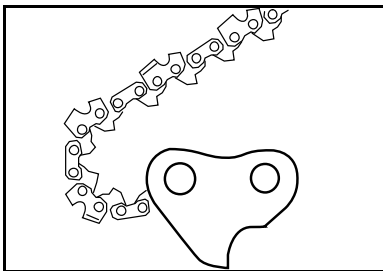

- **BAR GROOVE WIDTH** (inches/mm). The groove in the bar must match the width of the chain drive links.

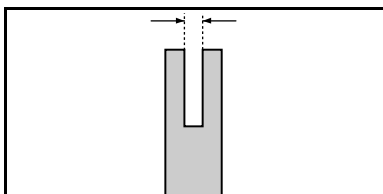

- **SAW CHAIN OIL HOLE AND HOLE FOR CHAIN TENSIONER**. The bar must be matched to the chain saw design.

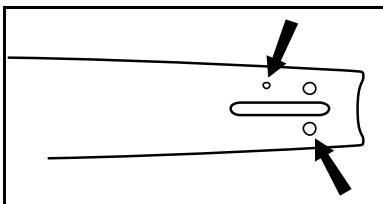

- Saw chain
  - **SAW CHAIN PITCH (=PITCH)** (inches)
  - **DRIVE LINK WIDTH** (mm/inches)

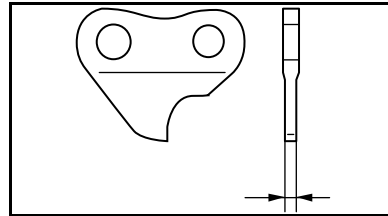

- **NUMBER OF DRIVE LINKS**
- **LEVEL OF KICKBACK REDUCTION**. The level of kickback reduction offered by a chain is indicated by its model number.

## Safety precautions and instructions



Special safety precautions must be observed when working with a chain saw because it is high-speed wood-cutting tool with very sharp cutters. Careless or improper use may cause serious or even fatal injury.



Before attempting to use this chain saw, please read this manual carefully until you completely understand and can follow all safety rules, precautions, operating and maintenance instructions.

## Safety precautions

### ! WARNING

- Observe all applicable local safety regulations, standards and ordinances.
- If you have not used this type of chain saw before, have your dealer or other experienced user show you how to operate your machine.
- Because a chain saw is high-speed wood-cutting tool, some special precautions must be observed to reduce the risk of accident and personal injury. Careless or improper use may cause serious or even fatal injury.
- The use of this chain saw may be hazardous. The saw chain has many sharp cutters. If the sharp edge contacts your body, they will cut you, even if the saw chain is not moving.
- Pay special attention to reactive forces, inclusive of kickback, because it is very dangerous.
- The exhaust from this machine may contain chemicals known by the State of California to cause cancer, birth defects or other reproductive harm.
- The noise emitted from this machine may be restricted to certain times by national or local regulations.
- Use this chain saw only for wood cutting. Do not use it for other purpose, since misuse may result in personal injury or property damage, including damage to the chain saw.
- Your chain saw is a one-person-operated machine. Do not allow other persons in the general work area,

even when starting. Stop the engine immediately if you are approached.

- Minors should never be allowed to use this chain saw. Do not allow other persons near the chain saw when starting or cutting. Keep bystanders, especially children, and animals out of the work area. Keep bystanders, children, and animals a minimum of 50 feet (15m) from the work area.
- The person who use this chain saw must be in good physical condition and mental health, and not under the influence of alcohol and drugs. Never use this chain saw when you are fatigued, sick, or upset. If you feel tired, take a break.
- The components of this machine generate an electromagnetic field during operation, which may interfere with some pacemakers. To reduce the risk of serious or fatal injury, persons with pacemakers should consult with their physician and the pacemaker manufacturer before operating this machine. In the absence of such information, CRAFTOP does not recommend the use of this machine by anyone who has a pacemaker.
- The owner of this machine is responsible for avoiding injury to third parties or damage to their property.

### CAUTION

Prolonged exposure to cold and/or vibration may result in injury. Read and follow all safety and operation instructions to minimize risk of injury. Failure to follow instructions may result in painful wrist/hand/arm injuries.

Raynaud's Phenomenon may affect the fingers of certain individual if a person is exposed to vibration and cold. Exposure to vibration and cold may cause tingling and burning sensations, followed by loss of color and numbness in the fingers. The following precautions are strongly recommended:

- Keep your body warm, especially the head, neck, hands, wrists, ankles and feet.
- Maintain good blood circulation by performing vigorous arm exercises during frequent work breaks.
- Limit the hours of operation, have a rest when you feel tired or fatigued.
- If you experience discomfort, redness, and swelling of the fingers followed by whitening and loss of feeling, consult your physician before continuing exposing yourself to cold and vibration.

Overusing the muscles and tendons of the fingers, hands, arms, and shoulders may cause soreness, swelling, numbness, weakness, and extreme pain in those areas.

- Avoid using your wrist in a bent, extended, or twisted posture. Instead, try to maintain a straight wrist position. Also, when grasping, use your whole hand, not just the thumb and index finger.
- Take periodic breaks to minimize repetition and let your hands have a rest.
- Reduce the speed and force with which you do the repetitive movement.
- Do exercise to strengthen your hands and arm muscles.

- Immediately stop using the machine and other power tools, and consult a doctor if you feel tingling, numbness, or pain in the fingers, hands, wrists, or arms.

### DANGER

All over head electrical conductors and communications wires can have electricity flow with high voltages. This machine is not insulated against electrical current. Never touch wires directly or indirectly, otherwise serious injury or even death may result.

### DANGER

Do not operate this machine indoors or in inadequately ventilated areas. Engine exhaust contains poisonous emissions and can cause serious injury or death.

## Clothing and PPE



**Wear proper clothing.**



**Wear eye, ear and head protection.**

Always wear appropriate personal protective equipments for chain saw operation, inclusive of eye protection, ear protection, and head protection.



**Face mask required.**

Operators who are sensitive to dust or other common airborne allergens may need to wear a dust mask.



**Hands protection.**

Always wear appropriate gloves for chain saw operation.



**Foot protection required.**

Steel toe shoes with anti-slip sole required in working area.

### WARNING

Most chain saw accidents happen when the saw chain touches the operator. You must wear approved clothing and approved personal protective equipments (PPE) whenever you use a chain saw.



**Ear, eye and head protection**

Always wear appropriate personal protective equipments for chain saw operation, inclusive of eye protection, ear protection, and head protection.



### Proper clothing.

Clothing must be sturdy but allow complete freedom of movement. Wear snug-fitting clothing, a type of overalls, long pants or chaps that contain pads of cut-retardant material. Avoid clothing that could get caught on branches or brush or moving parts of the machine. Do not wear a loose-fitting jacket, scarf, necktie, jewelry, flared or cuffed pants. Tie up and confine long hair with a hair net or cap, so it is secured above shoulder level.



### Hands protection

Always wear heavy-duty work gloves made of durable material (e.g. leather) for chain saw operation.



### Foot protection.

Wear sturdy boots with saw protection, steel toe and non-slip soles in your working area.



Always have a first aid kit at your working place

Personal protective equipments can not eliminate the risk of injury, but it will reduce the degree of injury if an accident does happen. Ask your chain saw dealer for help in choosing the right equipments.

Long-time or continuous exposure to high noise levels may cause permanent hearing impairment. Always wear approved hearing protection when operating a chain saw.

## Handle your chain saw safely

### **WARNING**

This chain saw must only be used to trim hedges or shrubs with thinner branches. Do not use the machine to cut trees, thick branches, grass, solid metal, sheet metal, plastic, or any other types of material.

Do not use the chain saw as a lever to lift, move or break objects, nor lock it on fixed supports.

Under any circumstance, you should not modify the original design of the chain saw without approval from CRAFTOP. Always use genuine spare parts. Unauthorized modifications or accessories may lead to serious or even fatal injury.

Under any circumstance, you should not operate your chain saw if it is damaged, improperly adjusted or maintained, or not completely or securely assembled.

Always inspect the chain saw before each use, and replace the parts immediately if it is worn, loose, damaged or missing.

- Always disconnect spark plug wire and place wire where it can not contact spark plug to prevent accidental starting when setting up, transporting, adjusting or making repairs except carburetor adjustments.
- Always hold the chain saw firmly with two hands when the engine is running. Do not operate a chain saw with one hand. Serious injury to the operator, helpers, bystanders or any combination of these persons may result from one-handed operation. **The chain saw MUST be used with two hands!** Place your left hand on the front handle and your right hand on the rear handle, with your thumbs and fingers tightly encircling the handles.

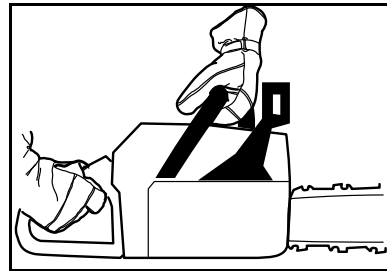

- Operate the chain saw only in a well-ventilated outdoor area. Never start or run the engine inside a closed room or building. Exhaust fumes contain dangerous carbon monoxide.
- Never operate the machine at night, at times of heavy fog, or at any other times when your field of vision might be limited and it would be difficult to maintain a clear view of the working area.
- During rain, storms at times of strong or gale-force winds, or at any other times when weather conditions might make it unsafe to use this machine.
- Carefully plan your cutting operation in advance. Never start cutting until you have a clear work area.
- Maintain footing and balance at all times. Do not stand on slippery, uneven or unstable surfaces. Do not operate the chain saw in odd position or on a ladder or ladders.
- Always shut off the engine before putting the chain saw down.
- Keep exhaust area clear of flammable debris. Avoid contact hot surfaces during and immediately after operation.
- Use a damp cloth, soft bristle brush, and/or air compressor (Max 25 PSI) to clear your chain saw. Do not use a pressure washer to clean chain saw as the solid jet of high pressure water may damage parts of the machine.

## Maintain in good work order

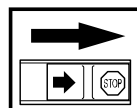

Switch off the engine by moving the stop switch to the STOP position before carrying out any checks or maintenance.



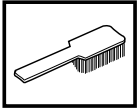

Regular cleaning is required.

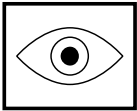

Visual check.



Protective glasses or a visor must be worn.

**CAUTION**  
 All chain saw service, other than the items listed in the maintenance section of this manual, should be performed by authorized service dealer or competent chain saw service personnel.

**WARNING**  
 Only use high-quality replacement parts in order to avoid the risk of accidents and damage to the power tool. If you have any questions in this respect, consult an authorized dealer or service center. CRAFTOP recommends the use of genuine spare parts. They are specifically designed to match your model and meet your performance requirements.

- Make sure that the saw chain stops moving when the throttle control trigger is released.
- Keep the handles dry, clean, and free of oil or fuel mixture.
- Keep fuel and oil caps, screws, and fasteners securely tightened.
- To reduce the risk of injury, always shut off the engine before carrying out any maintenance or repairs or cleaning the machine, only excepts carburetor and idle speed adjustments.
- Check the machine for loose/missing nuts, bolts, and screws. Tighten and/or replace as needed.
- Check that the cutting attachment is firmly attached and in safe operating condition.
- Do not turn the engine over on the starter with the spark plug boot or spark plug removed since there is otherwise a risk of fire from uncontained sparking.
- Check fuel system for leaks due to fuel tank damage, especially if the machine is dropped accidentally. If damages or leaks are found, do not use the machine any more, otherwise serious personal injury or property damage may occur. Have your machine repaired by authorized dealer or service center before next use.
- Check the fuel filler cap for leaks at regular intervals.
- To reduce the risk of fire, do not service or store your machine near open flames.
- Use only a spark plug type which is approved by CRAFTOP and make sure it is in good condition.
- Check the condition of the muffler. To reduce the risk of fire and damage to hearing, do not operate your machine if the muffler is damaged or missing.

- Do not touch a the muffler, spark plug, or other metallic parts of the engine while the engine is running or immediately shutting down, otherwise burn injury will result.

### Reduce the chance of kickback

**WARNING**  
 Kickback can happen very suddenly and violently; kicking the saw, bar and chain back at the operator. If this happens when the chain is moving, it can cause very serious or even fatal injuries. It is vital that you understand what causes kickback and that you can avoid it by taking care and using the right working technique.

The word kickback is used to describe the sudden reaction that happens when the upper quadrant of the tip of the bar (known as the "kickback zone") touches an object and the saw is kicked backwards. Kickback only occurs if the kickback zone of the bar touches an object.

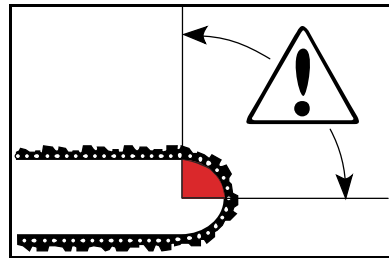
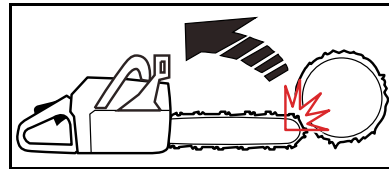

Kickback may occur when the moving saw chain near the upper quadrant of the guide bar nose contacts any object such as a log or branch, or when the wood closes in and pinches the saw chain in the cut. Note that contacting a foreign object in the wood can also result in loss of chain saw control.

Kickback always occurs in the cutting plane of the saw. Normally the saw and bar are thrown backwards and upwards towards the operator. However the saw may move in a different direction depending on the way it was being used when the kickback zone of the bar touched the object.

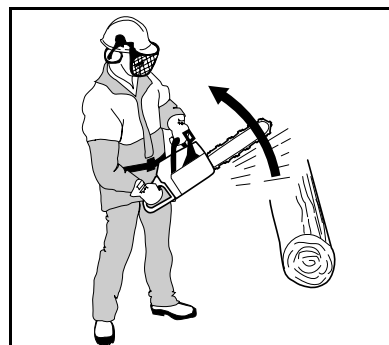

Take great care when you cut with the top edge of the bar, i.e. when cutting from the underside of the object. This is known as cutting on the push stroke. The chain tries to push the saw back towards the operator. Unless the operator resists this pushing force there is a risk that the saw will move so far backwards that only the kickback zone of the bar is in contact with the tree. This will cause kickback.

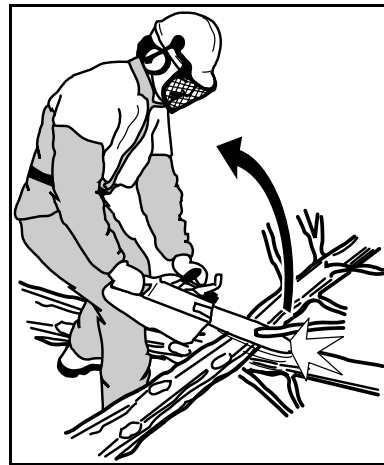
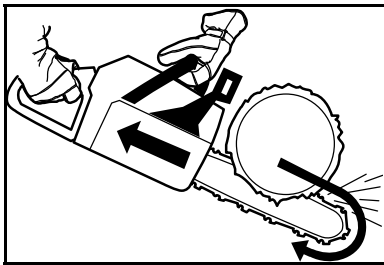

- **Rotational Kickback** can occur when the moving chain contacts an object at the upper tip of the guide bar. This contact can cause the chain to dig into the object, which stops the chain for an instant. The result is a lightning fast, reverse reaction which kicks the guide bar up and back toward the operator.
- **Pinch-Kickback** can occur when the wood closes in and pinches the moving saw chain in the cut along the top of the guide bar and the saw chain is suddenly stopped. This sudden stopping of the chain results in a reversal of the chain force used to cut wood and causes the saw to move in the opposite direction of the chain rotation. The saw is driven straight back toward the operator.
- **Pull-In** can occur when the moving chain contacts a foreign object in the wood in the cut along the bottom of the guide bar and the saw chain is suddenly stopped. This sudden stopping pulls the saw forward and away from the operator and could easily cause the operator to lose control of the chain saw.

- Cutting with the bottom edge of the bar, i.e. from the top of the object downwards, is known as cutting on the pull stroke. In this case the saw pulls itself towards the tree and the front edge of the saw provides a natural rest when cutting. Cutting on the pull stroke gives you better control over the saw and the position of the kickback zone.

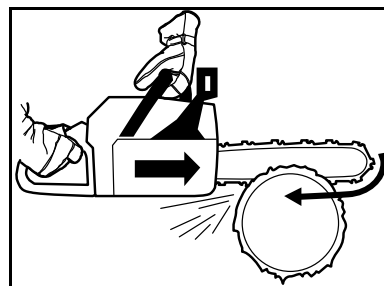

• **Avoid Pinch-Kickback:**

- Be extremely aware of situations or obstructions that can cause material to pinch the top of or otherwise stop the chain.
- Do not cut more than one log at a time.
- Do not twist the saw as the bar is withdrawn from an undercut when bucking.

• **Avoid Pull-In:**

- Always begin cutting with the engine at full speed and the saw housing against wood. Use wedges made of plastic or wood.
- Never use metal to hold the cut open.

• **Reduce the chance of kickback**

Recognize that kickback can happen. With a basic understanding of kickback, you can reduce the element of surprise which contributes to accidents.

- Most kickback accidents happen during limbing. Make sure you are standing firmly and that there is nothing in the way that might make you trip or lose your balance. Lack of concentration can lead to kickback if the kickback zone of the bar accidentally touches a branch, nearby tree or some other object.

- Never let the moving chain contact any object at the tip of the guide bar.
- Keep the working area free from obstructions such as other trees, branches, rocks, fences, stumps, etc. Eliminate or avoid any obstruction that your saw chain could hit while you are cutting. When cutting a branch, do not let the guide bar contact branch or other objects around it.
- Keep your saw chain sharp and properly tensioned. A loose or dull chain can increase the chance of kickback occurring. Check tension at regular intervals with the engine stopped, never with the engine running. Make sure the chain brake nuts are securely tightened after tensioning the chain. When you replace the bar and chain use only combinations that are recommended by CRAFTOP.
- Begin and continue cutting at full speed. If the chain is moving at a slower speed, there is greater chance of kickback occurring.
- Cut one log at a time.
- Use extreme caution when reentering a previous cut.
- Do not attempt cuts starting with the tip of the bar (plunge cuts).
- Watch for shifting logs or other forces that could close a cut and pinch or fall into chain.



- Use the Reduced-Kickback Guide Bar and Low-Kickback Chain specified for your chain saw.

**WARNING**  
The risk of kickback is increased if you use the wrong cutting equipment or a chain that is not sharpened correctly. The wrong combination of bar and chain can increase the risk of kickback!

### Maintain good control of chain saw

**WARNING**  
To reduce the risk of serious or even fatal injury to the operator or bystanders from loss of control, never use the chain saw with one hand. Always hold the chain saw firmly with both hands when the engine is running.

**WARNING**  
To reduce the risk of cutting injuries, keep hands and feet away from the cutting tool. Never touch a moving tool with your hand or any other part of your body.

Keep a good, firm grip on the chain saw with both hands when the engine is running and Don't let go. A firm grip will help you reduce kickback and maintain control of the saw.

- Always place your left hand on the front handle and your right hand on the rear handle. Never reverse right and left hand positions for any type of cutting whether you are right handed or left handed.
- Position your left hand on the front handle bar so it is in a straight line with your right hand on the rear handle when making bucking cuts. Keep your left arm straight with the elbow locked.
- Wrap your fingers and thumb around the handles. You should use this grip whether you are right-handed or left-handed. This grip minimizes the effect of kickback and lets you keep the saw under control. Do not let go of the handles!

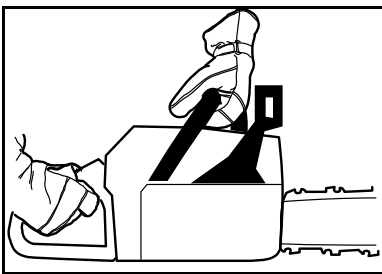

- Keep proper footing and balance at all times. Stand with your weight evenly balanced on both feet. Stand slightly to the left side of the saw to keep your body from being in a direct line with the cutting chain.
- Pay special caution when working on slippery ground, slopes, or uneven ground.
- Do not overreach. Do not cut above shoulder height, and not try to cut with the tip of the saw bar. It is difficult to maintain control of chain saw above shoulder height.



- To reduce the risk of injury from loss of control, never work on a ladder or any other insecure support, otherwise you could be drawn or thrown off balance and lose control of the chain saw.
- Never put pressure on the chain saw when reaching the end of a cut. The pressure may cause the bar and rotating saw chain to pop out of the cut or kerf, go out of control and strike the operator or some other object. If the rotating saw chain strikes some other object, a reactive force may cause the moving saw chain to strike the operator.

### Transporting your chain saw

**WARNING**  
Always stop the engine before putting the chain saw down. Carrying a chain saw with the engine running may be extremely dangerous.  
Accidental acceleration of the engine can cause the saw chain to rotate. Always engage the chain brake when taking the machine more than a few steps.

- When transporting your chain saw by hand, the engine must be shut off, the chain brake must be engaged, and the saw chain and guide bar must be covered with the chain guard (scabbard) and in the proper position (for example, grip the top handle, place the muffler away from your body, and the saw chain to the rear). Avoid touching hot parts of the machine, especially the muffler and gear housing, otherwise you could suffer serious burns.

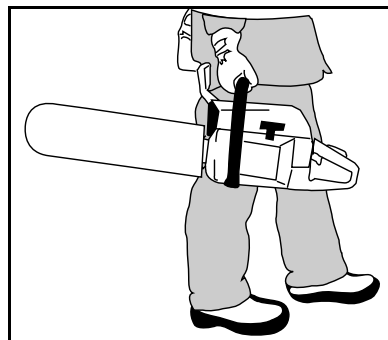

- When transporting your chain saw in a vehicle, the saw chain and guide bar should be covered with the

chain guard (scabbard) and properly secured to avoid turnover, fuel spillage and damage to your machine.

## Handle fuel with caution

You chain saw use a gasoline-oil mixture for fuel.

 **WARNING**  
Gasoline is an extremely flammable fuel. Pay high attention when mixing, storing or handling, otherwise serious personal injury may result.



If spilled and ignited by a spark or other ignition source, gasoline can cause fire and serious burn injury or property damage.



Do not smoke or bring any fire or flame while handling fuel or while operating the chain saw. Note that combustible fuel vapor may escape from the fuel system.

- Mix and pour fuel in a well ventilated outdoor area on bare ground; store fuel in a cool, dry well ventilated place; and use an approved, marked container for all fuel purposes. Wipe up all fuel spills before starting the chain saw.
- Eliminate all sources of sparks or flame (i.e. smoking, open flames, or work that can cause sparks) in the areas where fuel is mixed, poured, or stored. Always shut off the engine and allow it to cool down before refueling.
- Always use with caution when handling fuel. Wipe up all spills and then move the chain saw at least 10feet (3 meters) from the fueling point before starting the engine.
- To reduce the risk of fire and explosion, fuel your machine only in a well-ventilated area, outdoors away from flames, pilot lights, heaters, electric motors, and other sources of ignition
- Always shut off the engine before refueling, let the machine cool down in a non-combustible area, not on dry leaves, straw, paper, etc. Do not fuel a hot engine because fuel may spill out and cause a fire.
- Loose a bit of the fuel cap carefully so as to allow any pressure build-up in the fuel tank to release slowly and avoid fuel spillage.. Never remove the fuel cap when engine is running!
- If you spill fuel, wipe the machine immediately. If fuel spills on your clothing, change it immediately.
- Tight the fuel cap securely to the proper position, make sure it does not loosen or come off due to the machine vibrations.
- To reduce the risk of serious or fatal burn injuries, check for fuel leakage. If fuel leakage is found, do not start or run the engine until leak is fixed.
- Do not inhale fuel fumes as they are toxic.
- Store the machine and fuel in an area where fuel vapors cannot reach sparks or open flames from water heaters, electric motors or switches, furnaces, etc.

## Before starting the engine

A area within a minimum radius of 50feet (15m) from the using the machine should be considered as a hazardous area, into which on one should enter. If necessary, yellow warning rope and warning signs should be placed around the perimeter of the area. When work is to be performed simultaneously by two or more persons, special care should also be taken to constantly look around or otherwise check for the presence and locations of other people working, so as to maintain sufficient safety distance between each person.

Before starting the engine, take off the chain guard (scabbard), and check that your machine is properly assembled and in good condition

- Check cutting equipment is correctly fitted and adjusted.
- Check the fuel system for leaks, paying high attention to visible parts such as the fuel tank cap, hose connections and the manual fuel pump (if equipped). If there are any leaks or damage, do not start the engine because of potential risk of fire. Have your machine repaired by an authorized dealer or service center before using it again.
- The engine stop switch must move easily in direction of STOP position and spring back to the normal START position.
- Smooth action of throttle trigger lockout and throttle trigger - The throttle trigger must return automatically to the idle position by itself.
- Check that the spark plug boot is secure – a loose boot may cause arcing that could ignite combustible fumes and cause a fire.
- Saw chain securely mounted and in good condition (clean, move freely, not warped, properly sharpened).
- Never attempt to modify the controls or safety devices in any way.
- Keep all handles dry and clean, free from oil and dirt – for safe control of the machine.
- To reduce the risk of accidents, do not operate your machine if it is damaged or not properly assembled.

## When starting the engine

 **WARNING**  
Note that the saw chain continue to run for a short period after you let go of the throttle trigger, due to flywheel effect.

- Start the engine at least 10feet (3m) from the fueling spot, outdoors only.
- Keep bystanders, especially children and animals at least 50feet (15m) from the operating point. If you are approached, immediately stop the engine.
- Place the machine on firm ground in an open and well ventilated area. Make sure you have good balance and secure footing. Hold the machine securely. The saw chain must not contact the ground and all other obstructions because they may begin to run when the engine starts.

- Your machine is designed to be operated by one person only. Do not allow other persons in the work area even when starting.
- To reduce the risk of injury, avoid contact with the saw chain.
- Do not drop start the power tool, just follow the way and start the engine as described in this manual.
- Never start the engine by standing on the cutting attachments side.
- Check idle speed setting: The saw chain must not move when the engine is idling with the throttle trigger released. If it continues to move even after the throttle trigger has been completely released, shut off the engine and take the machine to your authorized dealer or service center for inspection and/or repair.

**i information**  
*When a new machine is first operated, in the first few minutes grease may come out of the gear case. But, since this is excessive grease, there is no cause of alarm. Just wipe it off with the engine stopped for next use*

### During operation

**! WARNING**  
 Moving parts can amputate fingers or cause severe injuries. Keep hands, clothing and loose objects away from all moving parts. Always stop engine, disconnect spark plug, and make sure all moving parts have come to a complete stop before removing obstructions, clearing debris, or servicing unit.



Do not touch any moving parts, especially the saw chain, while the motor is running. If the saw chain become jammed by thick branches or other obstructions, switch off the engine immediately before attempting to free the saw chain – there is otherwise a risk of injury.



Hot surface.  
 Do not touch.

- Always carry related tools, equipments, spare parts, and consumables with you:
  - Attached tools in the product package.
  - Personal protective equipments.
  - Properly reserved fuel
  - Spare parts.
  - Things to notify your working are (rope, warning signs, etc.).
  - Whistle (for collaboration or emergency).
  - Hatchet or saw (for removal of obstacles).
- Check that there are no bystanders, children, and animals in the general work area. If someone comes:
  - Guard against hazardous situations at all times. Warn adults to keep children and pets away from

- your working area. Be careful if you are approached. Injury may result from flying debris.
- If someone calls out or otherwise interrupts you while working, always be sure to shut off the engine before turning around. Avoid operating which people, especially children are nearby.
- Always be aware of surroundings and stay alert for possible hazards that you may not hear due to the noise of the machine.
- Make sure you always have good balance and secure footing. Place your feet slightly apart (slightly further apart than the width of your shoulders), so that your weight is distributed evenly across both legs, and always be sure to maintain a steady, even posture while working.
- Take special care in slippery conditions (ice, wet ground, snow), on slopes or uneven ground.
- Clear away fallen branches, scrub and cuttings.
- Watch out for obstacles (roots, tree stumps or holes) which could cause you to trip or stumble.
- When working at heights:
  - Always use a lift bucket.
  - Never work on a ladder or in a tree.
  - Never work on an insecure support.
  - Never operate your machine with one hand.
- Watch the saw chain at all times, do not cut areas of the hedge that you cannot see clearly. Check the conditions of working area to avoid any accident by hitting hidden obstacles, such as stumps, stones, cans, or broken glass.
- Be extremely careful when cutting tall hedges, check the other side of the hedge before starting work.
- Inspect the hedge and work area to avoid damaging the saw chain:
  - Remove stones, rocks, pieces of metal and other solid objects.
  - When working close to the ground, make sure that no sand, grit or stones get between the saw chain.
  - Take particular care when cutting hedges next to or against wire fences.
- Make sure the idle speed setting is correct. The saw chain must not run when the engine is idling with the throttle trigger released. If the saw chain still run, have your machine checked by an authorized dealer or service center, to make proper adjustments or repairs. Check and correct the idle speed setting regularly.
- Note that the saw chain continue to run for a short period after you let go of the throttle trigger, due to flywheel effect.
- The gearbox becomes hot during operation. To reduce the risk of burn injury, do not touch the gearbox housing.
- Be particularly alert and cautious when wearing hearing protection because your ability to hear warnings (shouts, alarms, etc.) is restricted.
- To reduce the risk of accidents, take sufficient break in good time to avoid tiredness or exhaustion.

- Work calmly and carefully in daylight conditions and only when visibility is good. Stay alert so as not to endanger others.
- To reduce the risk of serious or fatal injury from breathing toxic fumes, ensure proper ventilation when working in trenches, hollows or other confined locations.
- To reduce the risk of accidents, stop work immediately in the event of nausea, headache, visual disturbances (e.g. reduced field of vision), problems with hearing, dizziness, deterioration in ability to concentrate. Apart from other possibilities, these symptoms may be caused by an excessively high concentration of exhaust gases in the work area.
- Operate your machine so that it produces a minimum of noise and emissions. Do not run the engine unnecessarily, accelerate the engine only when working. To avoid noise complaints, in general operate the machine between 8AM and 5PM on weekdays, and 9AM to 5PM on weekends, detail please refer to your local regulations.
- Do not operate your machine in the starting throttle position because engine speed cannot be controlled in this position.
- To reduce the risk of fire, do not smoke while operating or standing near your machine. Note that combustible fuel vapor may escape from the fuel system. Always clean plant residue, chips, debris, leaves and excess lubricant off the engine and muffler. Note that stop the engine before you perform the cleaning work.
- If your power tool is subjected to unusually high loads for which it was not designed (e.g. heavy impact or a fall), always check that it is in good condition before continuing work. Check the fuel system in particular for leaks and make sure the safety devices are working properly. Do not continue operating your machine if it is damaged. In case of doubt, consult your local authorized dealer or service center.
- Opening the throttle while the saw chain is blocked increases the load and reduces engine speed. The clutch then slips continuously and this causes overheating and damage to important components (e.g. clutch, polymer housing components) – and this can increase the risk of injury from the saw chain moving while the engine is idling.
- The dust that occurs during operation may be harmful to health. If dust levels are very high, wear a suitable respirator.
- Before leaving the power tool unattended: Shut off the engine.
- Check the saw chain at regular short intervals during operation or immediately if there is a noticeable change in cutting behavior:
  - Shut off the engine.
  - Wait until the saw chain have come to a complete standstill.
  - Check condition and tightness, look for cracks.
  - Check sharpness.



The dust that occurs during chain saw operation may be harmful to health. Operators who are sensitive to dust or other common airborne allergens may need to wear a dust mask.

## After finishing your work

- Always clean dust and dirt off the machine. Do not use any grease solvents for this purpose.
- Do not use a pressure washer to clean chain saw. The solid jet of high pressure water may damage parts of the machine.

## Assembly

### WARNING

Always shut off the engine and allow it cool down before carrying out any work on the chain saw.

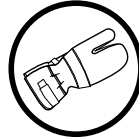

Always wear appropriate gloves when handling the saw chain, in order to protect your hands from injury. The chain is sharp and can cut you even when it is not moving!

If you received the chain saw in completely assembled status, repeat all steps to ensure your chain saw is properly assembled and all fasteners are secured.

## Mounting guide bar and chain

1. Check that the chain brake is in disengaged position by moving the front hand guard towards the front handle.

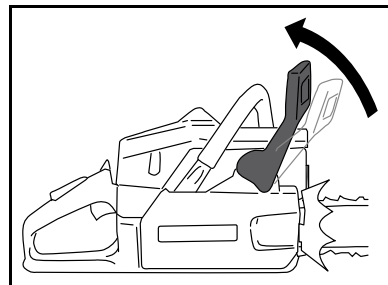

2. Take off the bar nuts and remove the clutch cover (chain brake). Take off the plastic shipping spacer (if present).

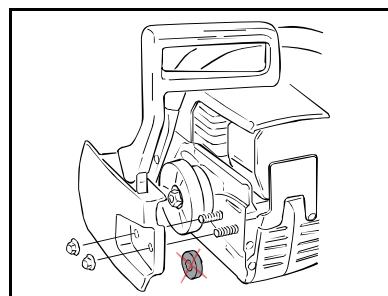

### WARNING

- Fit the bar over the bar bolts. Place the bar in its rearmost position. Place the chain over the drive sprocket and in the groove on the bar. Begin on the top side of the bar. Make sure that the edges on the cutting links are facing forward on the top side of the bar.

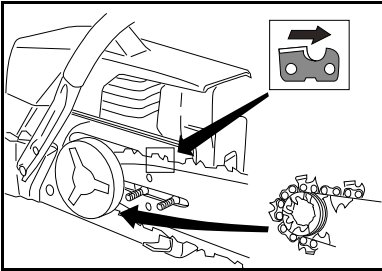

- Fit the clutch cover and locate the chain adjuster pin in the lower hole on the bar. Check that the drive links of the chain fit correctly on the drive sprocket and that the chain is in the groove on the bar. Tighten the bar nuts finger tight.

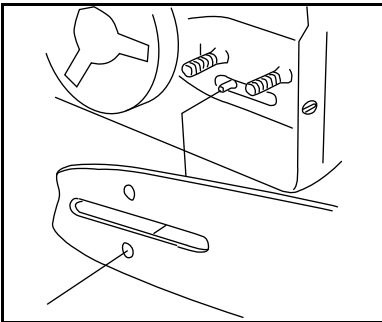

### **i** information

An adjusting pin and screw is used to adjust the tension of the chain. It is very important when assembling the bar that the pin located on the adjusting screw aligns into a hole in the bar. Turning the screw will move the adjustment pin up and down the screw. Locate this adjustment before you begin mounting the bar onto the saw. Illustration below shows the inside of chain brake, and the arrow indicates the adjustment located on chain brake.

- Tension the chain by using the combination wrench. Turn the chain adjuster screw clockwise. The chain should be tensioned until it fits snugly on the underside of the bar.

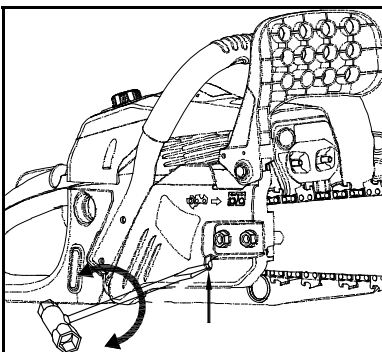

### **i** information

You can adjust the chain tension by loosening the chain brake nuts (B) and turning the adjusting screw (A) 1/4 of a turn while lifting up on the bar.

- If chain is too tight, turn adjusting screw 1/4 turn counterclockwise.
- If chain is too loose, turn adjusting screw 1/4 turn clockwise.

- Hold up the tip of the bar and tighten the chain. The chain is correctly tensioned when there is no slack on the underside of the bar, but it can still be turned easily by hand. Hold up the bar tip and tighten the bar nuts with the combination wrench (torque=12~15Nm).

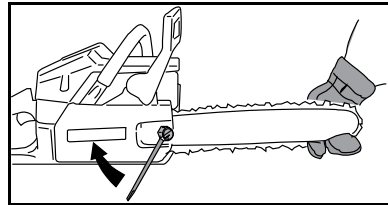

- When fitting a new chain, the chain tension has to be checked frequently until the chain is run-in. Check the chain tension regularly. A correctly tensioned chain gives good cutting performance and long lifetime.

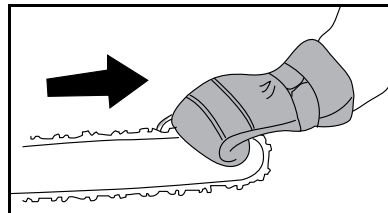

### Install a spike bumper

The optional bumper spike may be used as a pivot when making a cut.

To fit a spike bumper, please contact your authorized dealer or service center.

- Loosen and remove the chain brake nuts and the chain brake from the saw.
- Attach the bumper spike (optional) with the two screws as illustrated.

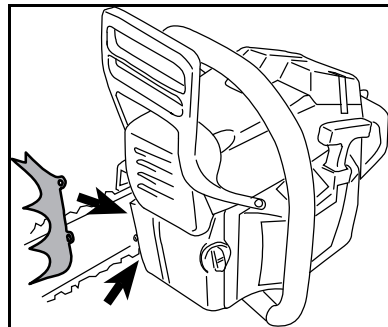



## Fuel and fueling

### Fuel

#### **WARNING**

Gasoline is very flammable. Avoid smoking or bringing any flame or sparks near fuel. Make sure to stop the engine and allow it cool down before refueling the machine. Select well-ventilated outdoor bare ground for fueling and move at least 3 m (10 ft) away from the fuming point before starting the engine.

#### **NOTICE**

*The chain saw is equipped with a two-stroke engine, and it is certified to operate on unleaded gasoline and two-stroke air cooled engine oil at a recommended mix ratio of 40:1. It is important to accurately measure the amount of oil to be mixed to ensure that the correct mixture is obtained. When mixing small amount of fuel, even small inaccuracies can drastically affect the ratio of the mixture.*

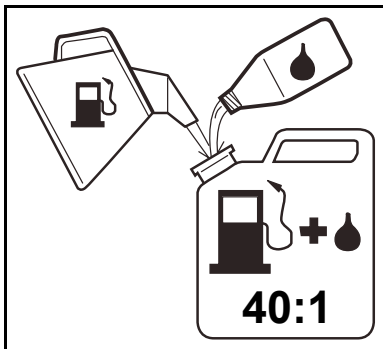

**Gasoline:** Use good quality unleaded or leaded petrol. Gasoline may contain up to 10% Ethanol (grain alcohol) or 15% MTBE (methyl tertiary-butyl ether). Gasoline containing methanol (wood alcohol) is NOT approved.

- Poor quality gasoline or oil may damage sealing rings, fuel lines or fuel tank of the engine.
- Unleaded gasoline is recommended to reduce the contamination of the air for the sake of your health and the environment.
- The lowest octane recommended is 90. If you run the engine on a lower octane grade than 90 so-called, knocking can occur. This gives rise to a high engine temperature, which can result in serious engine damage.
- If you use a gasoline of a lower octane value than prescribed, there is a danger that the engine temperature may rise and an engine problem such as piston seizing may consequently occur.
- When working with continuous high speed (e.g. delimiting), a higher octane grade is recommended.
- Exhaust emission are controlled by the fundamental engine parameters and components (for example, carburetion, ignition timing and port timing) without addition of any major hardware or the introduction of an inert material during combustion.
- Take care when handling gasoline. Avoid direct contact with the skin and avoid inhaling fuel vapor

**Two-stroke oil:** A two-stroke air-cooled engine oil meeting ISO-L-EGD (ISO/CD 13738) and J.A.S.O. FD Standards must be used. Do not use BIA or TCW (2 stroke water cooling type) mixed oil.

- Never use two-stroke oil intended for water cooled outboard motors, so-called, outboard oil.
- Never use oil intended for four-stroke engines.

### Mixing

1. Measure out the quantities of gasoline and oil to be mixed.
2. Put half of the gasoline into a clean container approved for fuel use.
3. Pour in entire amount of oil and agitate well.
4. Pour in the remaining amount of gasoline and agitate again for at least one minute. As some oil may be difficult to agitate depending on oil ingredients, sufficient agitation is necessary for the engine to last long. Be careful that, if the agitation is insufficient, there is an increase danger of early piston seizing due to abnormal lean mixture.

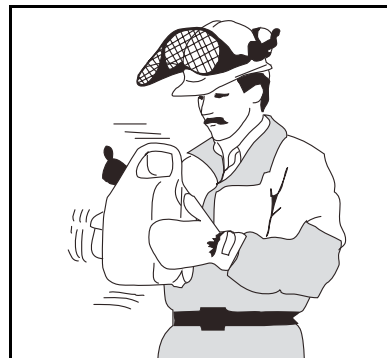

5. Put a clear indication on the outside of the container to avoid mixing up with gasoline or other containers.
6. Indicate the contents on outside of container for easy identification.

#### **NOTICE**

*Do not mix more than maximum one month's supply of fuel. If the saw is not used for some time, the fuel tank should be emptied and cleaned.*

### Fueling

#### **WARNING**

- Do not smoke or place warm objects in the vicinity of the fuel.
- Select bare ground for fueling.
- Always shut off the engine and allow it cool down before refueling the machine.
- Move at least 10 feet (3 meters) away from the fueling point before starting the engine.

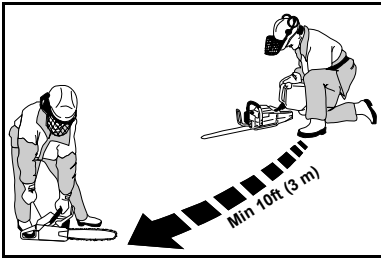

1. Before fueling, clean the filler cap and the area around it to ensure that no dirt falls into the tank.
2. Loosen a bit of the fuel cap carefully so as to allow any pressure build-up in the fuel tank to release slowly. Never remove the fuel cap when engine is running!
3. Put mixed fuel into the fuel tank to 80% of the full capacity. Make sure the fuel is well mixed by shaking the container before fuelling. Take care not to spill fuel while fueling and do not overfill the tank.
4. Tighten the fuel cap securely after fuelling.
5. Wipe up any fuel spillage around the fuel cap and fuel tank.

### **NOTICE**

*Experience indicates that alcohol blended fuels (called gasohol or using ethanol or methanol) can attract moisture which leads to separation and formation of acids during storage. Acidic gas can damage the fuel system of an engine while in storage. To avoid engine problems, empty the fuel system before storage for 30 days or longer. Drain the gas tank, start the engine and let it run until the fuel lines and carburetor are empty. Use fresh fuel next season. Never use engine or carburetor cleaner products in the fuel tank, otherwise permanent damage may occur.*

- If fuel without mixing of oil (raw gasoline), it will cause severe damage to the internal engine parts very quickly.
- Do not use gasohol, otherwise it can cause deterioration of rubber and/or plastic parts and disruption of engine lubrication.
- Do not use 4-cycle engine oil, otherwise it can cause spark plug fouling, exhaust port blocking, or piston ring sticking.
- Mixed fuels which have been left unused for a period of one month or more may clog the carburetor and result in the engine failing to operate properly.
- In the case of storing the product for a long period of time, clean the fuel tank after rendering it empty. Next, activate the engine and empty the carburetor of the composite fuel.
- In the case of scrapping the used mixed oil container, scrap it only at an authorized repository site.

### **NOTICE**

*If your fuel cap can not be tightened properly, it may be damaged or broken. Stop using the chain saw and take it to your authorized dealer or service center for repair.*

### **NOTICE**

*The volume of chain oil and fuel tanks are adjusted to each other. Therefore, always fill chain oil and fuel at the same time.*

## **Chain lubricant**

The chain bar and saw chain require continuous lubrication. Lubrication is provided by the automatic lubrication system when the oil tank is kept filled. Lack of oil will quickly ruin the bar and chain. Insufficient oil will cause overheating shown by smoke coming from the saw chain and/or discoloration of the chain bar.

The sizes of the chain oil tank and fuel tank have been chosen so that the saw will run out of fuel before running out of oil. This means that you should never run with a dry chain.

However, this safety feature requires that you use the right sort of chain oil (if the oil is too thin it will run out before the fuel), and that you adjust the carburetor as recommended (a weak mixture may mean that the fuel lasts longer than the oil). You should also use the recommended cutting equipment (a bar that is too long will use more chain oil). The above conditions also apply to models with an adjustable oil pump.

### **NOTICE**

*Never operate your chain saw without chain lubrication. If the chain runs dry, the whole cutting attachments will be irretrievably damaged within a very short time. Always check chain lubrication and the oil level in the tank before starting work.*

For automatic and reliable lubrication of the chain and bar, always use an environmentally compatible quality chain and bar lubricant with good adhesive characteristics.

### **NOTICE**

*The service life of the chain and guide bar depends on the quality of the lubricant. It is therefore essential to use only a specially formulated chain lubricant.*

In countries where no special chain oil is available, EP 90 transmission oil can be used.

### **NOTICE**

*Never use waste oil. Waste oil does not have the necessary lubricating properties, and it can result in damage to the oil pump, the bar and the chain. Renewed contact with waste oil can cause skin cancer. Moreover, waste oil is environmentally harmful.*

It is important to use oil of the right viscosity according to the air temperature.

In temperatures below 0°C (32°F) some oils become too viscous. This can overload the oil pump and result in damage to the oil pump components.

Contact your authorized dealer or service center when choosing chain oil.

1. Carefully and thoroughly clean the oil filler cap and the area around it to make sure that no dirt falls into the oil tank.

- Position the machine so that the oil filler cap is upwards.
- Open the oil filler cap.

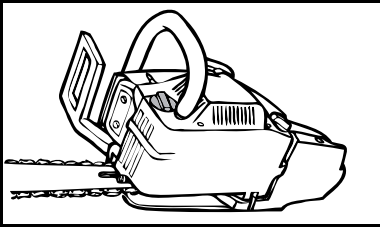

- Refill the oil tank every time you refuel. Take care not to spill chain oil while refilling, and do not overfill the tank.

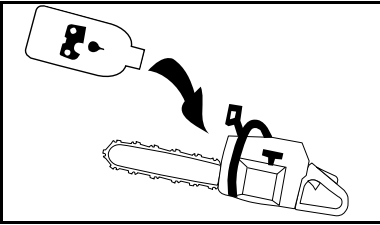

- Close the oil filler cap.

### **NOTICE**

The volume of chain oil and fuel tanks are adjusted to each other. Therefore, always fill chain oil and fuel at the same time.

There must still be a small amount of oil in the oil tank when the fuel tank is empty.

If the oil level in the tank does not go down, the reason may be a fault in the oil supply system, please check chain lubrication, clean the oil pipes, and contact authorized dealer or service center for assistance if necessary.

## Start and stop the engine

### **WARNING**

To reduce the risk of fire and burn injuries, start the engine at least 10feet (3m) from the fueling spot, outdoors only.

### **WARNING**

To reduce the risk of injury from saw chain contact and/or reactive forces, always engage the chain brake before starting the chain saw.

### **WARNING**

The saw chain has very sharp cutters and they will start moving upon the engine starts. Touching them may lead to severe personal injury. Avoid touching saw chain whenever possible, and always wear gloves to protect hands.

### **WARNING**

To reduce the risk of serious or even fatal injury:

- Never allow children or unauthorized persons access to the machine.

- Do not allow children or other unauthorized persons to attempt to start or otherwise use the machine.
- Never leave the machine unattended while working or during work breaks.
- After work, store the machine in a safe, secure location out of the reach of children and other unauthorized persons.
- Observe safety precautions and instructions.

## Pre-operation checklist

Follow the steps below before using the machine every time:

- Check and make sure you wear proper clothing and PPE.
- Check the starting location.
- Keep children or other unauthorized persons well away from work area where you plan to start the machine.
- Make sure that all the parts including saw chain and guide bar are installed properly, and there is no broken parts or lacks of any parts.
- Check the fuel level to make sure there is sufficient mixed fuel in the fuel tank.
- Check the chain oil level to make sure it is located at the proper position.
- Check there is no leakage of fuel and oil.
- Remove the chain guard (scabbard).
- Make sure that the saw chain are not touching ground or any other obstacles.
- Double-check and observe all safety precautions and instructions in this manual prior to starting the machine.

### **WARNING**

Do not use drop start. This method is very dangerous because you may lose control of the chain saw, and result in serious or even fatal injury.

## Start cold engine

### **WARNING**

When starting the engine, make sure that your body does not contact with the muffler. A hot muffler can cause serious burns.

- If necessary, fill fuel into the fuel tank and tighten the fuel cap (B) securely; accordingly, you need fill chain oil into the oil tank and tighten the oil cap (A) securely.

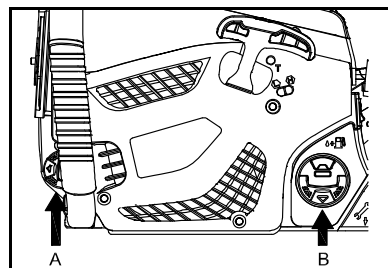



- Disengage the chain brake by pulling the hand guard towards the front handle.

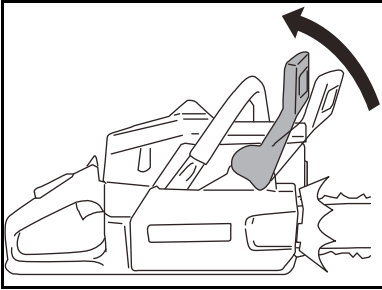

- Move the ignition switch to START position (I).

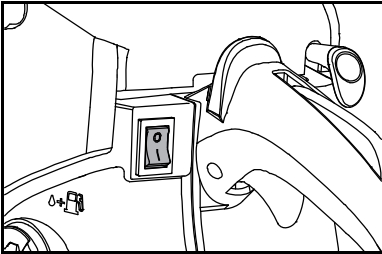

- Pull out the choke knob, so as to leave the choke in the CLOSE position.

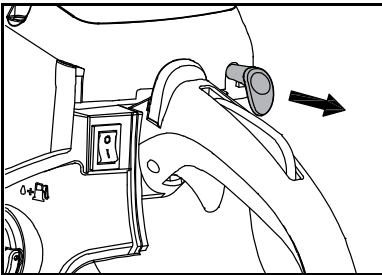

- Push down the throttle trigger lockout (D).
- Open the throttle (E) fully.
- Push the throttle latch (F) downwards.

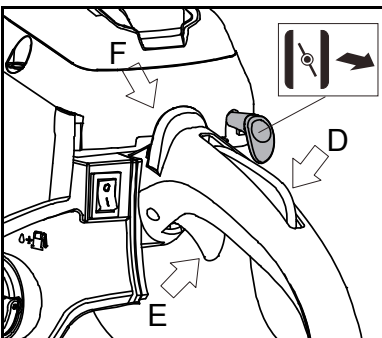

- Place the machine on a flat and firm ground in a clear area. Make sure that the saw chain are not touching ground or any other obstacles.
- Hold the chain saw firmly on the ground with you left hand on the front handle (your thumb should be under the handle), put your right foot into the rear handle and press down.

- Grip the starter rope handle securely with your right hand, pull it slowly until resistance is felt, then pull it rapidly until start the engine.



### NOTICE

Do not pull out the starter rope all the way, otherwise it might break.

Do not let the starter rope snap back by itself. Guide it slowly back into the housing, so that the starter rope can rewind properly.

### information

If the engine is new or after a long out-of-service period, it may be necessary to pull the starter rope several times to prime the fuel system.

- Push in the choke control immediately when the engine ignites and make repeated starting attempts. When the engine starts, rapidly give full throttle. Then the throttle latch will disengage.

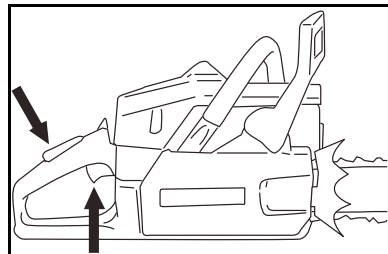

- Restart engine if necessary and allow the machine to warm up at idle engine speed for several minutes.

### NOTICE

If engine does not start with choke control lever in "OPEN" position after 5 pulls, repeat steps 2~ 11.

### NOTICE

When restarting the engine immediately after stopping it, leave the choke knob in "OPEN" position.

### WARNING

The saw chain must not move at idle speed, otherwise serious personal injury may result. Periodic carburetor adjustment may be necessary to assure saw chain does not move at idle speed. If saw chain moves at idle speed, have the carburetor readjusted by your local authorized dealer or service center.

## Start warm engine

The WARM starting procedure is almost same as COLD starting except the choke knob position.

To start warm engine, do not pull out the choke knob.

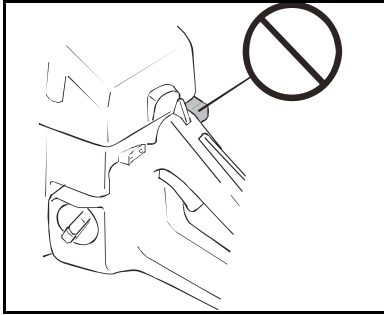

### **WARNING**

When starting the engine, make sure that your body does not contact with the muffler. A hot muffler can cause serious burns.

1. If necessary, fill fuel into the fuel tank and tighten the fuel cap securely; accordingly, you need fill chain oil into the oil tank and tighten the oil cap securely.
2. Disengage the chain brake by pulling the hand guard towards the front handle.

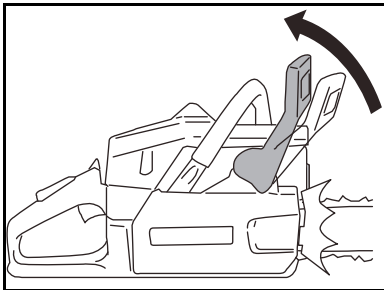

3. Move the ignition switch to START position (I).
4. Push in the choke knob, so as to leave the choke in the OPEN position.
5. Push down the throttle trigger lockout (D).
6. Open the throttle (E) fully.
7. Push the throttle latch (F) downwards.

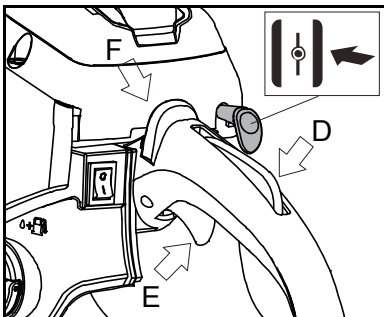

8. Place the machine on a flat and firm ground in a clear area. Make sure that the saw chain are not touching ground or any other obstacles.
9. Hold the chain saw firmly on the ground with you left hand on the front handle (your thumb should be under the handle), put your right foot into the rear handle and press down.
10. Grip the starter rope handle securely with your right hand, pull it slowly until resistance is felt, then pull it rapidly until start the engine.



### **NOTICE**

Do not pull out the starter rope all the way, otherwise it might break.

Do not let the starter rope snap back by itself. Guide it slowly back into the housing, so that the starter rope can rewind properly.

### **information**

If the engine is new or after a long out-of-service period, it may be necessary to pull the starter rope several times to prime the fuel system.

11. When the engine starts, rapidly give full throttle. Then the throttle latch will disengage.

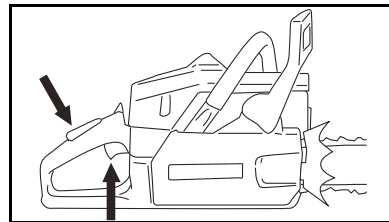

### **WARNING**

The saw chain must not move at idle speed, otherwise serious personal injury may result. Periodic carburetor adjustment may be necessary to assure saw chain does not move at idle speed. If saw chain moves at idle speed, have the carburetor readjusted by your local authorized dealer or service center.

## Stop the engine

1. Release throttle trigger and allow engine to return to idle speed for a few minutes.
2. Move ignition switch to STOP position (O).

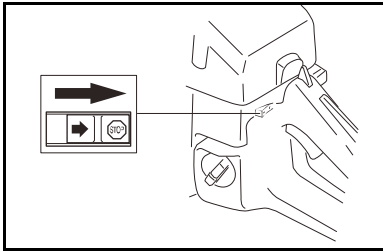

**WARNING**  
 If engine does not stop when ignition switch is moved to STOP position, move choke knob to CLOSE position to stall engine. Have your local authorized dealer or service center to repair ignition switch before using the machine again.

## Operation

### During the break-in period

A factory new machine should not be run at high engine speeds (with full throttle off load) for the first three tank of fuels. This can avoid unnecessarily high loads during the break-in period. As all moving attachments have to bed in during the break-in period, the frictional resistances in the shortblock are greater during this period. The engine achieve its maximum power after approximate 5 to 15 tank of fuel.

### During work

**NOTICE**  
 Do not make the fuel mixture leaner to achieve an apparent increase in power, otherwise this could damage the engine.

**NOTICE**  
 Open the throttle only when the chain brake is off. Running the engine at high speeds with the chain brake engaged (chain locked) could quickly damage the shortlock and chain drive system (clutch, chain brake)

**Check chain tension frequently:** A new saw chain must be tensioned more frequently than one that has been used already for an extended period.

**Chain cold:** Tension is correct when the chain fits snugly against the underside of the bar, but can still be pulled along the bar by hand.

**Chain at operating temperature:** The chain stretches and begins to sag. The drive links must not come out of the bar groove on the underside of the bar. Otherwise, the chain may jump off the bar, so it is necessary to re-tension the chain.

**NOTICE**  
 The chain contracts as it cools down. If it is not slackened off, it can damage the crankshaft and bearings.

**After a long period of full-throttle operation:** After a long period of full-throttle operation, allow engine to run for a while at idle speed so that the heat in the engine

can be dissipated by flow of cooling air. This protects engine-mounted components (ignition, carburetor) from thermal overload.

### After finishing work

Slacken off the chain if you have re-tensioned it at operating temperature during work.

**NOTICE**  
 Always slacken off the chain again after finishing work. The chain contracts as it cools down. If it is not slackened off, it can damage the crankshaft and bearings.

**Short-term storage:** Wait of engine to cool down. Keep the machine with a full tank of fuel in a dry place, well away from sources of ignition, until you need it again.

**Long-term storage:** See the section of "Storage".

### Operation in winter

During winter time, powder snow and cold weather can cause running problems, such as:

- Too low engine temperature.
- Icing on the air filter and carburetor.

Therefore some special measures are required:

- Partly reduce the air inlet of the starter and by doing that increase the engine temperature.
- Preheat the intake air to the carburetor by removing the special plug between the cylinder and the carburetor space.

The cylinder cover has a special feature for use in cold climates. It is possible to open up a hole in the cylinder cover which can then be plugged with a rubber plug during warmer weather.

### Operation at temperature 0°C (32°F) or colder

Break out the hole or remove the rubber plug so that preheated air from the cylinder can enter the carburetor chamber and prevent the air filter from icing up.

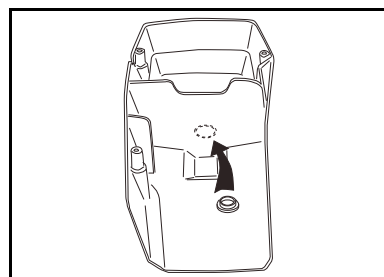

### Operation at temperature -5°C (23°F) or colder

If the saw is used in severe cold or powder snow conditions you can fit a special cover over the starter unit. This reduces the flow of cold air and prevents large amounts of snow from being sucked in.

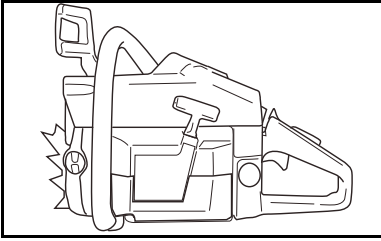

## ! NOTICE

If a special winter kit is assembled or measures are taken to increase the engine temperature, a readjustment to normal setting has to be done when the saw is used under normal conditions. Otherwise, there is a risk of overheating, which can cause severe engine damage.

## ! NOTICE

Any maintenance other than that described in this manual must be carried out by your servicing dealer.

## Working techniques

This section describes basic working techniques with safety rules for using a chain saw to perform your sawing work. This information is no substitute for professional skills and experience. If you get into a situation where you feel unsafe, stop and seek expert advice.

## ! WARNING

Do not attempt any task that you feel unsure of!

## ! WARNING

Before using a chain saw you must understand the effects of kickback and what causes it.

## ! WARNING

Before using a chain saw you must understand the difference between sawing with the top and bottom edges of the bar.

## ! WARNING

Engine exhaust is hot, and it can cause serious burns. Engine exhaust contains Carbon Monoxide (CO), a poison gas. Breathing CO can cause unconsciousness, serious injury, or death. Always position your machine so that exhaust is directed away from your face and body.

## ! WARNING

Saw chain is very sharp. Touching them may lead to severe personal injury. Avoid touching saw chain whenever the cutting attachments are moving, and always wear gloves to protect your hands.

## ! WARNING

The engine continues running even when the saw chain has stopped due to an obstruction. If this occurs, stop the engine, disconnect ignition cable and remove the obstruction.

## i information

Observe all country-specific or municipal rules and regulations for trimming hedges.

Do not use your machine during other people's normal rest periods.

- Check chain tension before first use and after 1 minute of operation.
- Cut wood only. Do not cut metal, plastics, masonry non-wood building materials, etc.
- Stop the saw if the chain strikes a foreign object. Inspect the saw and repair or replace parts as necessary.
- Keep the chain out of dirt and sand. Even a small amount of dirt will quickly dull a chain and thus increase the possibility of kickback.
- Practice cutting a few small logs using the following techniques to get the feel of using your saw before you begin a major sawing operation.
- Squeeze the throttle trigger and allow the engine to reach full speed before cutting.
- Begin cutting with the saw frame against the log.
- Keep the engine at full speed the entire time you are cutting.
- Allow the chain to cut for you. Exert only light downward pressure. If you force the cut, damage to the bar chain or engine can occur.
- Release the throttle trigger as soon as the cut is completed, allowing the engine to idle. If you run the saw at full throttle without a cutting load, unnecessary wear can occur to the chain, bar and engine.
- Avoid losing control when cut is complete, do not put pressure on saw at end of cut.
- Stop the engine before setting the saw down after cutting. Switch the engine off before leaving your chain saw for any length of time.

## Basic safety rules

1. Look around you to make sure there are no people, animals or other objects nearby that might affect your work, and to make sure that none of the above might come within reach of your saw or be injured by falling trees.

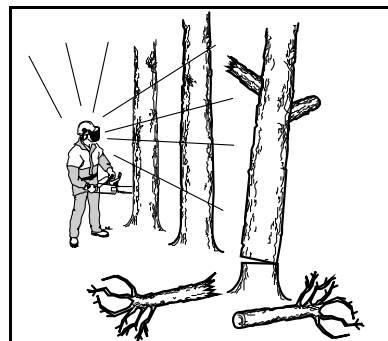

Follow the instructions above, but do not use a chain saw in a situation where you cannot call for help in case of an accident.

- Do not use the saw in bad weather, such as dense fog, heavy rain, strong wind, intense cold, etc. Working in cold weather is tiring and often brings added risks, such as icy ground, unpredictable felling direction, etc.
- Take great care when removing small branches and avoid cutting bushes (i.e. cutting many small branches at the same time). Small branches can be grabbed by the chain and thrown back at you, causing serious injury.



- Check the area around you for possible obstacles such as roots, rocks, branches, ditches, etc., in case you have to move suddenly. Take great care when working on sloping ground.



- Take the utmost care when cutting through branches or logs that are in tension. A log or branch that is in tension can suddenly spring back into its natural position before or after you cut it. If you stand on the wrong side or start cutting in the wrong place it may strike you or your chain saw. This could make you lose control and cause a serious accident.

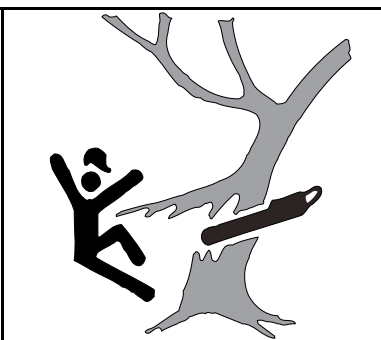

- Before moving your chain saw switch off the engine and lock the chain using the chain brake. Carry the saw with the bar and chain pointing backwards. Fit a guard to the bar before carrying the saw any distance.

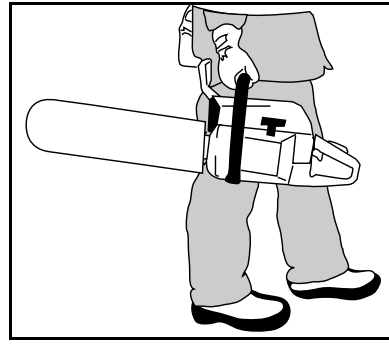

- Never put a chain saw down while the engine is running unless you have it in clear view and the chain brake is on. Switch the engine off before leaving your chain saw for any length of time.

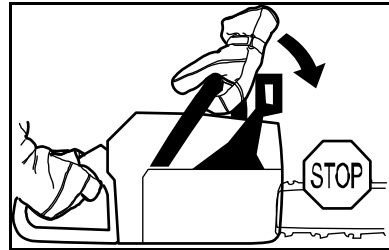

## Tree felling techniques

### ⚠ WARNING

It takes a lot of experience to fell a tree. Inexperienced operators of chain saws should not fell trees. Never attempt a task you are unsure of.

### ⚠ WARNING

Check for broken or dead branches which can fall while cutting causing serious injury. Do not cut near buildings or electrical wires if you do not know the direction of tree fall, nor cut at night since you will not be able to see well, nor during bad weather such as rain, snow, or strong winds, etc. If the tree makes contact with any utility line, the utility company should be notified before beginning to cut.

- Carefully plan your sawing operation in advance.
- Clear the work area. You need a clear area all around the tree so you can have secure footing.
- The chain saw operator should keep on the uphill side of the terrain as the tree is likely to roll or slide downhill after it is felled.
- Study the natural conditions that can cause the tree to fall in a particular direction.

### ⚠ WARNING

During critical felling operations, hearing protectors should be lifted immediately when sawing is completed so that sounds and warning signals can be heard.

#### A. Safe distance

Make sure there is enough room for the tree to fall. The safe distance between a tree that is to be felled and anyone else working nearby is at least 2 1/2 tree lengths. Maintain a distance of 2 1/2 tree lengths from

the nearest person or other objects. Engine noise can drown out a warning call.

Make sure that no-one else is in this "risk zone" before or during felling.

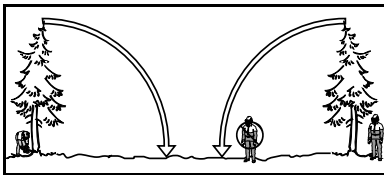

### B. Felling direction

The aim is to fell the tree in the best possible position for subsequent limbing and cross-cutting. You want it to fall on ground where you can move about safely.

The main point to avoid is letting the tree fall onto another tree. It can be both difficult and dangerous to remove a tree in such a position.

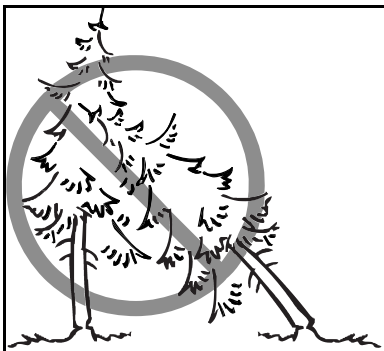

Once you have decided which way you want the tree to fall you must judge which way the tree would fall naturally. Natural conditions that can cause a tree to fall in a particular direction include:

- The wind direction and speed.
- The lean of the tree. The lean of a tree might not be apparent due to uneven or sloping terrain. Use a plumb or level to determine the direction of tree lean.
- Weight and branches on one side.
- Weight of snow
- Surrounding trees and obstacles.

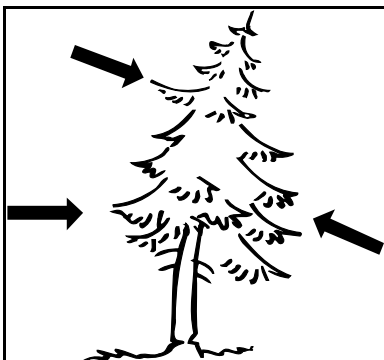

You may find you are forced to let the tree fall in its natural direction because it is impossible or dangerous to try to make it fall in the direction you first intended.

Another very important factor, which does not affect the felling direction but does affect your safety, is to make sure the tree has no damaged or dead branches that might break off and hit you during felling. Check for broken or dead branches which can fall on you while cutting.

### C. Plan safe retreat path

Plan a clear retreat path to the rear and diagonal to the line of fall. Remove any undergrowth from the base of the tree and check the area for obstacles (stones, branches, holes, etc.) so that you have a clear path of retreat when the tree starts to fall. Your path of retreat should be roughly 135 degrees behind the intended felling direction.

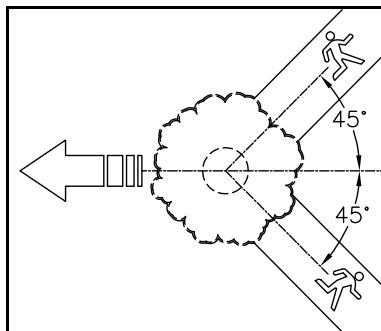

Remove any branches that are in the way. To do this it is best to work from the top down and keep the trunk between you and the chain saw. Never limb above shoulder height.

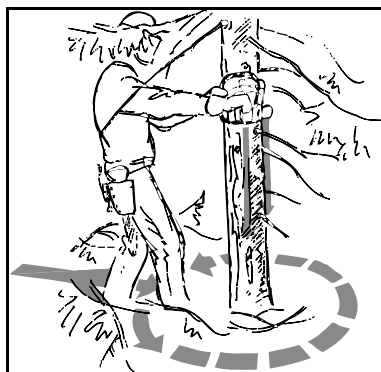

### D. Felling

Felling is done using three cuts. First you make the DIRECTIONAL CUTS, which consist of the TOP CUT (CUT1) and the BOTTOM CUT (CUT2); followed by the FELLING CUT (CUT3). By placing these cuts correctly you can control the felling direction very accurately.



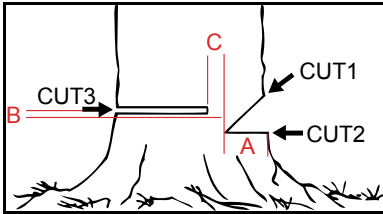

**NOTICE**  
 If the tree has large buttress roots, remove them before making the notch. If using saw to remove buttress roots, keep saw chain from contacting ground to prevent dulling of the chain. Remove dirt, stones, loose bark, nails, staples, and wire from the tree where cuts are to be made.

1. To make the DIRECTIONAL CUT, you begin with the TOP CUT (CUT1), Cut through 1/4 of the diameter (A) of the tree. Stand to the right of the tree and cut downwards at an angle of 45°.

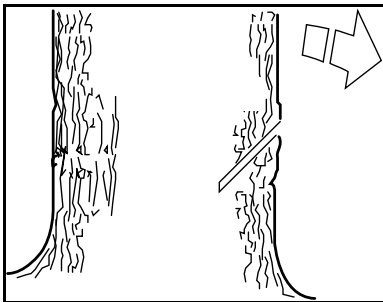

2. Make the BOTTOM CUT (CUT2), so that it finishes at the end of the TOP CUT (CUT1). Once the notch is cut, remove the notch of wood from the tree.

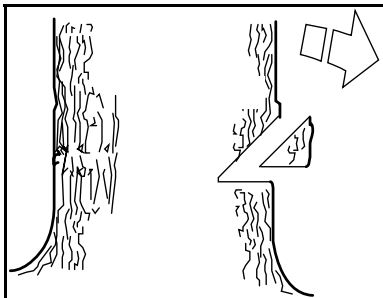

**information**  
 The directional cut should run 1/4 of the diameter (A) through the trunk and the angle between the TOP CUT and BOTTOM CUT should be 45°.

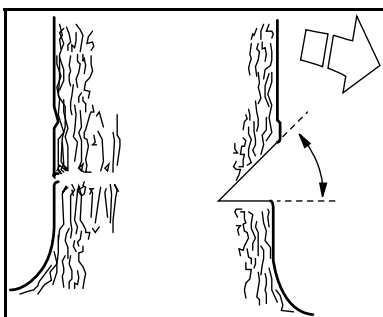

**information**  
 The line where the two cuts meet is called the DIRECTIONAL CUT LINE.  
 This line should be perfectly horizontal and at right angles (90°) to the chosen felling direction.

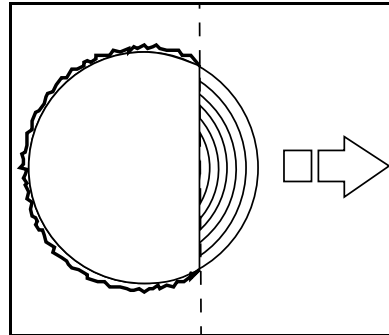

**information**  
 The felling cut is made from the opposite side of the tree and it must be perfectly horizontal. Stand on the left side of the tree and cut with the bottom edge of the bar.

3. After removing the wood from the notch, make the felling cut on the opposite side of the notch. Make the FELLING CUT about 5 cm (A=2 inches) above the flat section of the DIRECTIONAL CUT. This will leave enough uncut wood between the felling cut and the notch to form a hinge. This hinge will hold tree on stump and control the tree falling in the correct direction.
4. Set the spike bumper (if one is fitted) in behind the breaking strip. Use full throttle and bring the bar and chain slowly into the tree. Make sure the tree does not start to move in the opposite direction to your intended felling direction.

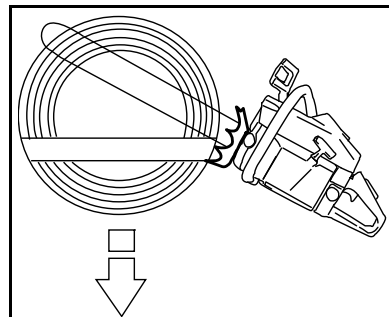

5. Drive a WEDGE or BREAKING BAR into the cut as soon as it is deep enough.

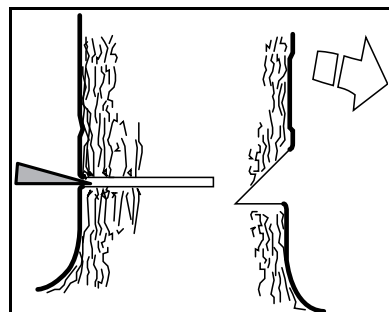

6. Finish the FELLING CUT parallel with the DIRECTIONAL CUT LINE so that the distance between them is at least  $1/10$  (C) of the trunk diameter. The uncut section of the trunk is called the BREAKING STRIP.

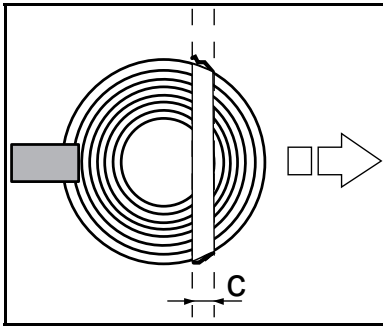

**i information**

The BREAKING STRIP act as hinges that control the felling direction of the falling tree.

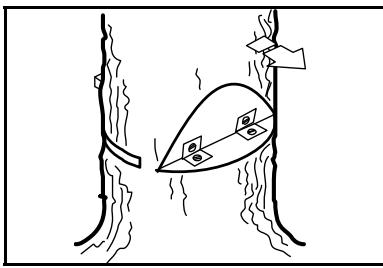

7. When the felling cut and directional cut are complete the tree should start to fall under its own weight or with the aid of a FELLING WEDGE or BREAKING BAR.

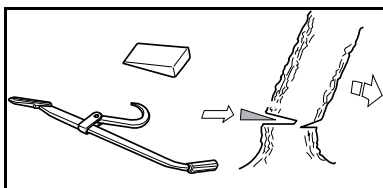

**! WARNING**

All control over the felling direction is lost if the BREAKING STRIP is too narrow or if the directional cut and felling cut are badly placed.

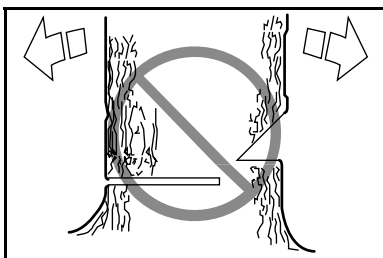

**i information**

We recommend that you use a bar that is longer than the diameter of the tree, so that you can make the

FELLING CUT and DIRECTIONAL CUT with single cutting stokes.

**! WARNING**

Unless you have special training, we advise you not to fell trees with a diameter larger than the bar length of your chain saw.

**! WARNING**

Before felling cut is complete, use wedges to open the cut when necessary to control the direction of fall. Avoid kickback and chain damage, only use wood or plastic wedges, never use steel or iron wedges.

- Be alert to signs that the tree is ready to fall: cracking sounds, widening of the felling cut, or movement in the upper branches.
- As tree starts to fall, stop saw, put it down, and get away quickly on your planned retreat path.
- Do not cut down a partially fallen tree with your saw. Be extremely cautious with partially fallen trees that may be poorly Supported. When a tree doesn't fall completely set the saw aside and pull down the tree with a cable winch, block and tackle, or tractor.

**Freeing a tree that has fallen badly**

To reduce the high accident risk, pay special attention when you try to free a tree that has fallen badly.

A. Freeing a "Trapped tree"

The safest method is to use a winch.

- Tractor-mounted

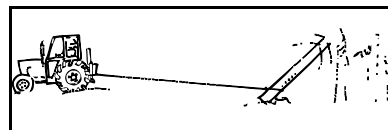

- Portable

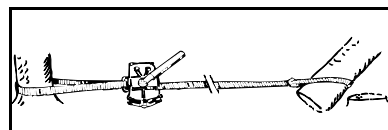

B. Cutting trees and branches that are in tension Preparations:

- Work out which way the tree or branch will move if released and where the natural "BREAKING POINT" is (i.e. the place it would break if it was bent even more).

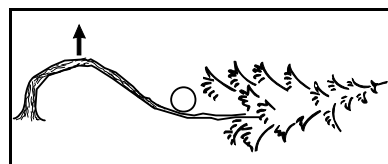

- Decide which is the SAFEST way to release the tension and whether YOU are able to do it safely. In complicated situations the only safe method is to put aside your chain saw and use a winch.



### General advice:

- Position yourself so that you will be clear of the tree or branch when it springs free.

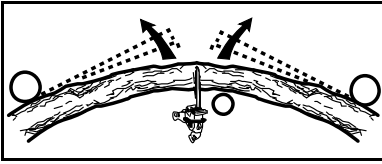

- Make one or more cuts at or near the BREAKING POINT. Make as many cuts of sufficient depth as necessary to reduce the tension and make the tree or branch break at the BREAKING POINT.

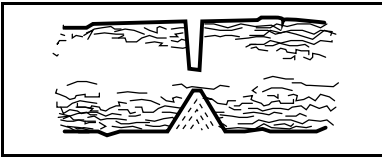

**WARNING**  
Never cut straight through a tree or branch that is in tension!

### Cutting a fallen tree (Bucking)

**information**  
Always use full throttle when cutting!  
Reduce the speed to idle after every cut (running the engine for too long at full throttle without any load can lead to serious engine damage).  
If cutting from above, set the machine on the pull stroke.  
If cutting from below, set the machine on the push stroke.

**information**  
**Cutting:** General term for cutting through wood.  
**Limbing:** Cutting limbs off a fallen tree.  
**Splitting:** When the object you are cutting breaks off before the cut is complete.

There are five (5) important factors you should consider before making a cut:

1. Make sure the bar will not jam in the cut.

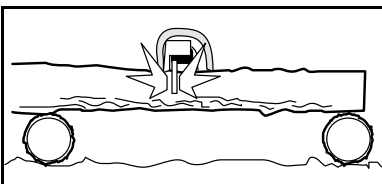

2. Make sure the log will not split.

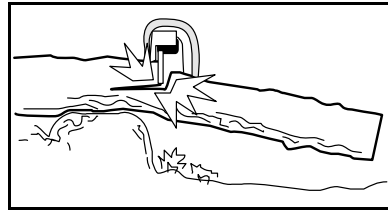

3. Make sure the chain will not strike the ground or any other object during or after cutting.

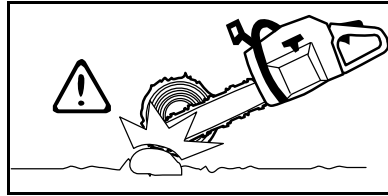

4. Make sure whether there is a risk of kick-back.

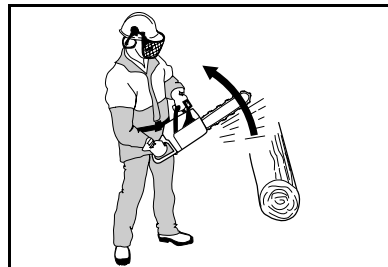

5. Make sure whether the conditions and surrounding terrain affect your safety when working.

Two factors decide whether the chain will jam or the log will split. The first is how the log is supported and the second is whether it is in tension.

In most cases you can avoid these problems by cutting in two stages; from the top and from the bottom of the log. You need to support the log so that it will not trap the chain or split during cutting.

**WARNING**  
If saw becomes pinched or hung in a log, don't try to force it out. You can lose control of the saw resulting in injury and/or damage to the saw. Turn off the saw, drive a plastic or wood wedge into the cut until the saw can be removed easily. Restart the saw and carefully reenter the cut. To avoid kickback and chain damage, do not use a metal wedge. Do not attempt to restart your chain saw when it is pinched or hung in a log.

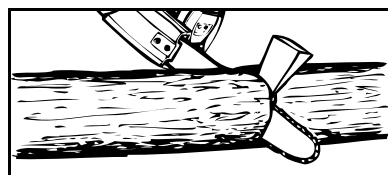

The following instructions describe how to handle most types of situation that you will be faced with when using a chain saw.

**WARNING**

Do not stand on the log being cut. Any portion can roll causing loss of footing and control. Do not stand downhill of the log being cut.

- Cut only one log at a time.
- Cut shattered wood very carefully, sharp pieces of wood could be flung toward operator.
- Use a sawhorse to cut small logs. Never allow another person to hold the log while cutting and never hold the log with your leg or foot.
- Do not cut in an area where logs, limbs, and roots are tangled such as in a blown down area. Drag the logs into a clear area before cutting by pulling out exposed and cleared logs first.

### Type of cutting used for bucking

**Overcutting** begins on the top side of the log with the bottom of the saw against the log. When overcutting, use light downward pressure.

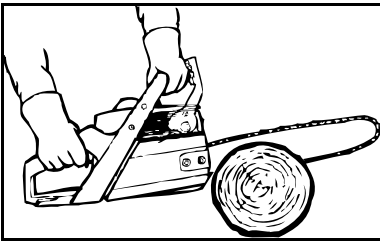

**Undercutting** involves cutting on the under-side of the log with top of saw against the log. When undercutting use light upward pressure. Hold saw firmly and maintain control. The saw will tend to push back toward you.

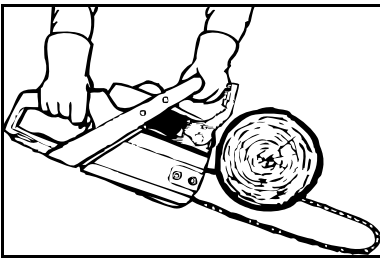

**! WARNING**  
Never turn saw upside down to undercut. The saw can not be controlled in this position.

**! WARNING**  
Always make your first cut (Cut 1) on the compression side of the log. The compression side of the log is where the pressure of the logs weight is concentrated.

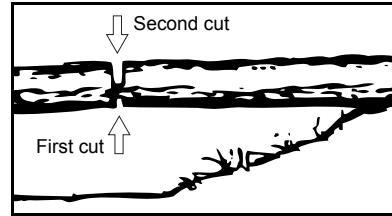
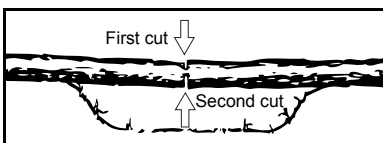

### Bucking without a support

Overcut through 1/3 of the diameter of the log.

- Roll the log over and finish with a second overcut.
- Watch for logs with a compression side to prevent the saw from pinching. See illustrations for cutting logs with a compression side.

### Bucking using a log or support stand

- Remember your first cut is always on the compression side of the log (Refer to the illustrations below for your first and second cut).
  - Our first cut should extend 1/3 of the diameter of the log.
  - Finish with your second cut.
- A. Using a log for support.

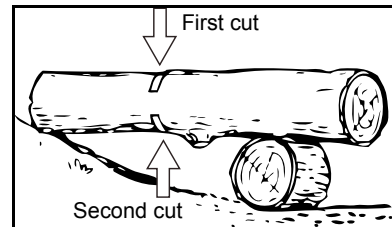
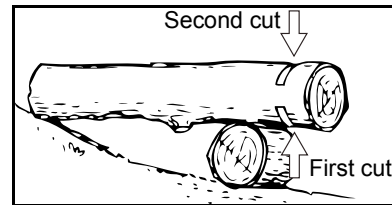

- B. Use a support stand

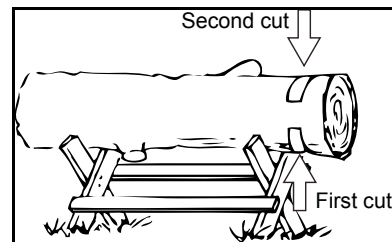

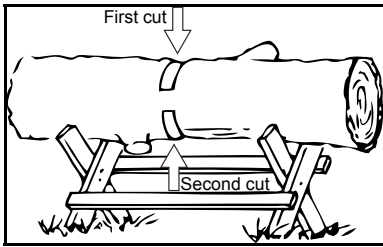

## Limbing and pruning

### **WARNING**

Be alert for and guard against kickback. Do not allow the moving chain to contact any other branches or objects at the nose of the guide bar when limbing or pruning. Allowing such contact can result in serious injury.

Never climb into a tree to limb or prune. Do not stand on ladders, platforms, a log, or in any position which can cause you to lose your balance or control of the saw.

- Work slowly, keeping both hands firmly gripped on the saw. Maintain secure footing and balance.
- Watch out for spring poles. Use extreme caution when cutting small size limbs. Slender material may catch the saw chain and be whipped toward you or pull you off balance.
- Be alert for spring back. Watch out for branches that are bent or under pressure. Avoid being struck by the branch or the saw when the tension in the wood fibers is released.
- Keep a clear work area. Frequently clear branches out of the way to avoid tripping over them.

### A. LIMBING

- Always limb a tree after it is cut down. Only then can limbing be done safely and properly.
- Leave the larger limbs underneath the felled tree to support the tree as you work.
- Start at the base of the felled tree and work toward the top, cutting branches and limbs. Remove small limbs with one cut.
- Keep the tree between you and the chain. Cut from the side of the tree opposite the branch you are cutting.
- Remove larger, supporting branches with the cutting techniques described in BUCKING WITHOUT A SUPPORT.
- Always use an overcut to cut small and freely hanging limbs. Undercutting could cause limbs to fall and pinch the saw.

### B. PRUNING

### **WARNING**

Limit pruning to limbs shoulder height or below. Do not cut if branches are higher than your shoulder. Get a professional to do the job.

1. Make your fist cut 1/3 of the way through the bottom of the limb.
2. Make a second cut from top all the way through the limb.

3. Cut a third overcut leaving a 1 to 2 inch collar from the truck of the tree.

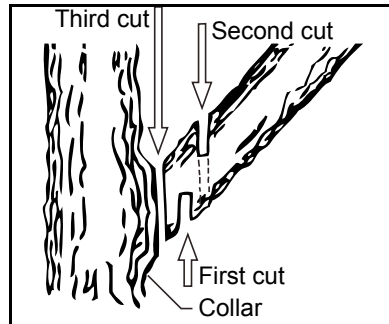

## Maintenance and care

### Maintenance schedule

<b>IMPORTANT!</b> Time intervals shown are maximum. Actual use and your experience will determine the frequency of required maintenance.		Before starting to work	Daily and/or at the end of work	Whenever tank is refilled	Weekly	Monthly	Quarterly	if there is a failure	if there is a damage	As required
		System / Component	Maintenance Procedure							
<b>Complete machine</b>	Visual inspection (Condition, leak)	√		√						
	Clean		√							
<b>Throttle trigger, Choke knob, Stop switch</b>	Function test	√		√						
<b>Chain brake</b>	Function test	√		√						
	Have it inspected by dealer									√
<b>Air filter</b>	Inspect				√					
	Clean				√					
	Replace					√			√	
<b>( Automatic Oiler ) Oil pump</b>	Inspect	√								
	Replace									√
<b>Oil filter</b>	Inspect						√			
	Replace							√		√
<b>Oil tank</b>	Clean					√				
<b>Carburetor</b>	Inspect				√					
	Adjust									√
<b>Fuel filter</b>	Inspect				√					
	Replace								√	√
<b>Fuel tank</b>	Clean					√				
<b>Saw chain</b>	Inspect	√			√					
	Sharpen									√
	Tension									√
	Replace	√						√	√	
<b>Guide bar</b>	Inspect	√								
	Clean									√
	Deburr		√							
	Replace							√	√	
<b>Sprocket</b>	Inspect				√					
	Replace									√
<b>Spark Plug</b>	Inspect					√				
	Clean					√				

	Adjust					√		√		
	Replace							√	√	√
Spark arresting screen in muffler	Inspect					√				
	Clean									√
	Replace							√	√	
Cylinder Exhaust Port	Inspect					√				
	Clean					√				
Piston and ring	Inspect					√				
	Replace									√
Fasteners, inclusive of Bolts, Screws, Nuts	Inspect	√								
	Tighten									√
	Replace									√
Safety Information Label	Replace							√		

### ⚠ WARNING

Moving parts can amputate fingers or cause severe injuries. Keep hands, clothing and loose objects away from all moving attachments.

Always stop engine, disconnect spark plug, and make sure all moving parts have come to a complete stop before removing obstructions, clearing debris, or servicing unit.

Allow the machine to cool down before performing maintenance service. Wear gloves to protect hands from sharp edges and hot surfaces.

Before cleaning, inspecting or repairing the machine, make sure that engine has been stopped and cooled down. Disconnect the spark plug to prevent accidental starting.

### ℹ NOTICE

*SPECIAL TRAINING IS REQUIRED to service and repair chain saws. This is especially true of chain saw safety equipment. If your chain saw fails any of the checks described below take it to your authorized dealer. When you buy any of our products we guarantee the availability of professional repairs and service. If the retailer who sells your saw is not a authorized service center, ask him for the address of your nearest service center.*

## Chain brake and front hand guard

### A. Checking brake band wear

Brush off any sawdust, resin and dirt from the chain brake and clutch drum. Dirt and wear can impair operation of the brake.

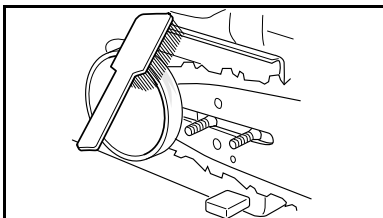

Regularly check that the brake band is at least 0.6 mm thick at its thinnest point.

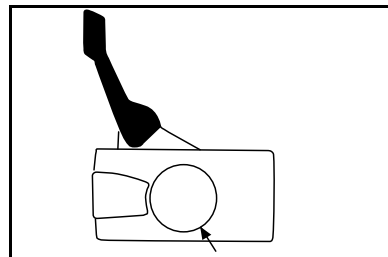

### B. Checking the front hand guard

- Make sure the FRONT HAND GUARD is not damaged and that there are no visible defects such as cracks.

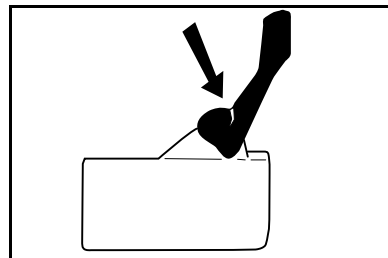

- Move the front hand guard forwards and back to make sure it runs freely and that it is securely anchored to the clutch cover.

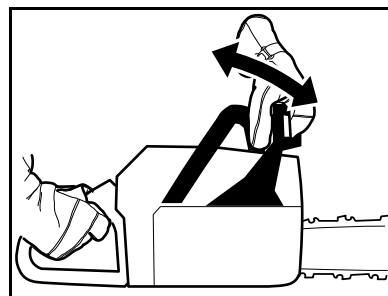

### C. Checking the inertia brake release

Hold the chain saw over a stump or other firm object. Let go of the front handle so that the bar falls onto the stump.



When the bar hits the stump the brake should be applied.

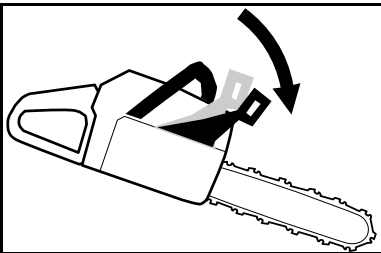

### D. Checking the brake trigger

1. Start the chain saw and place it on firm ground. Make sure the chain does not touch the ground or any other object.
2. Grasp the saw firmly, wrapping your fingers and thumbs around the handles.
3. Apply full throttle and activate the chain brake by tilting your wrist forward onto the front hand guard. Do not let go of the front handle.
4. The chain should stop immediately.

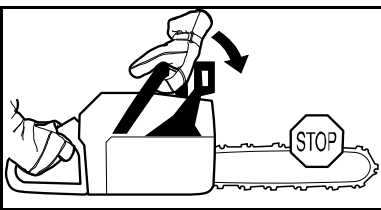

### Throttle lock

1. Make sure the throttle control is locked at the idle setting when you release the throttle lock.

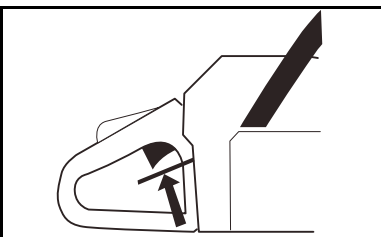

2. Press the throttle lock and make sure it returns to its original position when you release it.

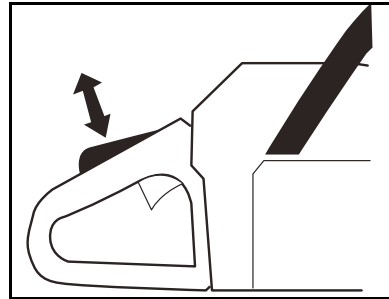

3. Check that the throttle control and throttle lock move freely and that the return springs work properly.

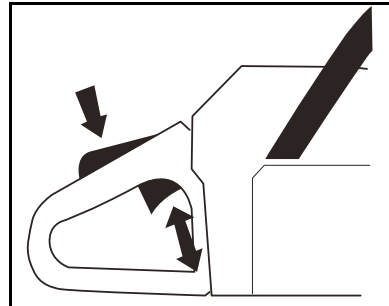

4. Start the saw and apply full throttle. Release the throttle control and check that the chain stops and remains stationary. If the chain rotates when the throttle is on idle setting you should check the carburetor idle adjustment.

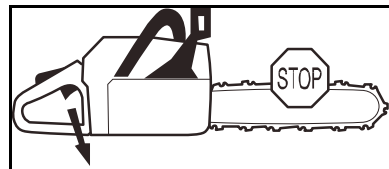

### Chain catcher

Check that the CHAIN CATCHER is not damaged and is firmly attached to the body of the saw.

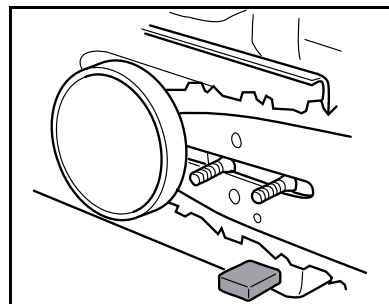

### Right hand guard

Check that the right hand guard is not damaged and that there are no visible defects, such as cracks.

## Vibration damping system

Regularly check the vibration damping units for cracks or deformation, make sure the vibration damping units are securely attached to the engine unit and handles.

## Stop switch

Start the engine and make sure the engine stops when you move the stop switch to the stop setting.

## Muffler

**WARNING**  
Never use a chain saw that has a faulty muffler.

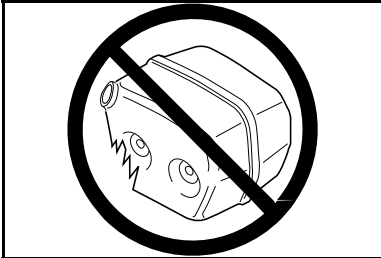

Regularly check that the muffler is securely attached to the chain saw.

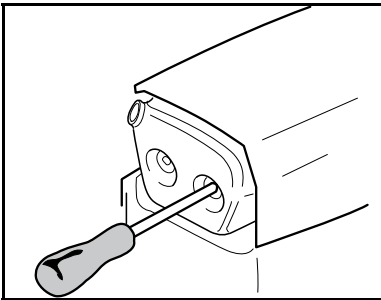

If the muffler on your saw is fitted with a spark arrestor mesh this must be cleaned regularly. A blocked mesh will cause the engine to overheat and may lead to serious damage.

**WARNING**  
Never use a muffler if the spark arrestor mesh is missing or defective.

**WARNING**  
Never use a chain saw with faulty safety equipment. Carry out the checks and maintenance measures described in this section above. If your chain saw fails any of these checks, contact your authorized dealer or service center to get it repaired.

## Sharpening your chain and adjusting raker clearance

**WARNING**  
The risk of kickback is increased with a badly sharpened chain!

A. General information on sharpening cutting teeth

- Never use a blunt chain. When the chain is blunt you have to exert more pressure to force the bar through the wood and the cuttings will be very small. If the chain is very blunt it will not produce any cuttings at all, just wood powder.
- A sharp chain eats its way through the wood and produces long, thick cuttings.

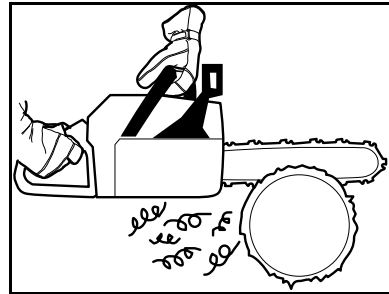

- The cutting part of the chain is called the CUTTING LINK and this consists of a CUTTING TOOTH (A) and the RAKER LIP (B). The cutting depth is determined by the difference in height between the two.

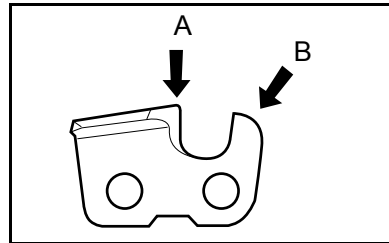

- When you sharpen a cutting tooth there are five important factors to consider.

- Filing angle

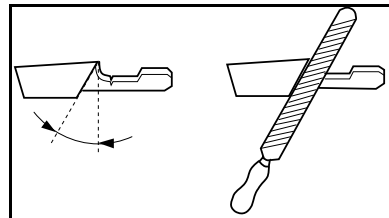

- Cutting angle

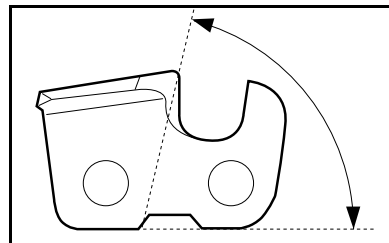

- File position

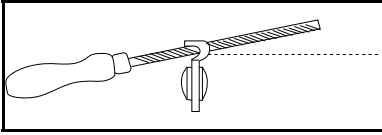

- Round file diameter

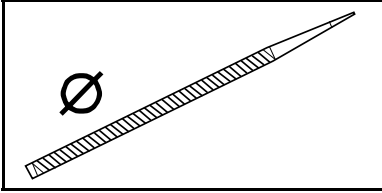

- File depth

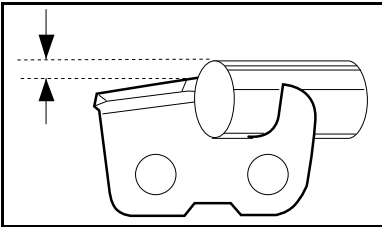

It is very difficult to sharpen a chain correctly without the right equipment. We recommend you use a file gauge. This will help you obtain the maximum kickback reduction and cutting performance from your chain.

**⚠ WARNING**  
 The following faults will increase the risk of kickback considerably.

- File angle too large
- Cutting angle too small
- File diameter too small

### B. Sharpening cutting teeth

To sharpen cutting teeth, you will need a ROUND FILE and a FILE GAUGE. See the section of Technical specification for information on the size of file and gauge that are recommended for your saw chain.

1. Check that the chain is correctly tensioned. A slack chain is difficult to sharpen correctly.

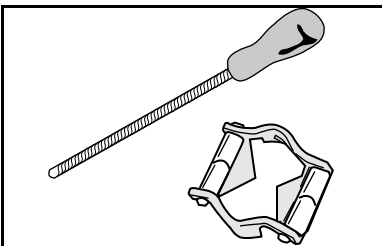

2. Always file cutting teeth from the inside face, reducing the pressure on the return stroke. File all the teeth on one side first, then turn the saw over and file the teeth on the other side.

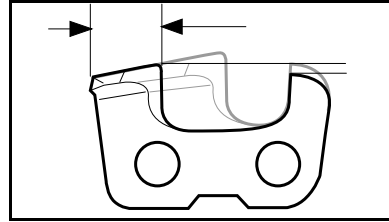

3. File all the teeth to the same length. When the length of the cutting teeth is reduced to 4mm (0.16inch) the chain is worn out and should be replaced.

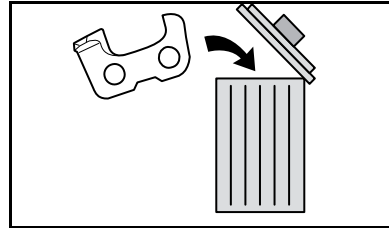

### C. General advice on setting raker clearance

When you sharpen the cutting teeth you reduce the RAKER CLEARANCE (cutting depth). To maintain cutting performance you must file back the raker teeth to the recommended height.

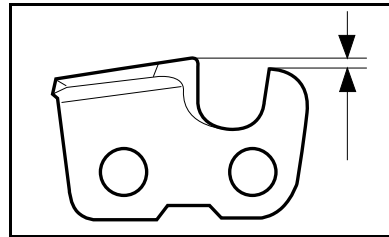

- On a low-kickback cutting link the front edge of the raker lip is rounded. It is very important that you maintain this radius or bevel when you adjust the raker clearance.

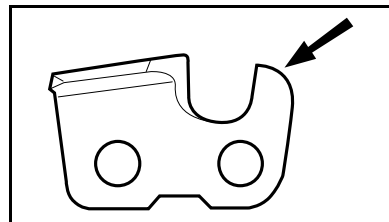

- We recommend the use of a raker gauge to achieve the correct clearance and bevel on the raker lip.

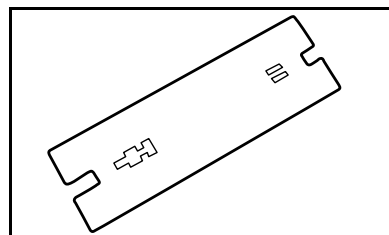



**! WARNING**  
 The risk of kickback is increased if the raker clearance is too large!

D. Setting the raker clearance

Before setting the raker clearance the cutting teeth should be newly sharpened.

We recommend that you adjust the raker clearance every third time you sharpen the chain.

**i information**  
 This recommendation assumes that the length of the cutting teeth is not reduced excessively.

1. To adjust the raker clearance you will need a FLAT FILE and a RAKER GAUGE.

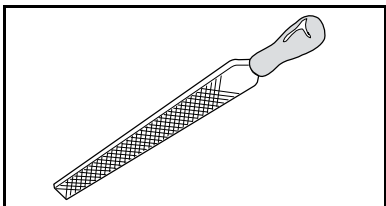

2. Place the gauge over the raker lip.
3. Place the file over the part of the lip that protrudes through the gauge and file off the excess. The clearance is correct when you no longer feel any resistance as you draw the file over the gauge.

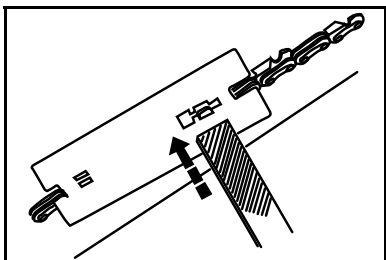

**Check the chain tension**

**! NOTICE**  
 When adjusting chain tension, make sure the chain brake nuts are finger tight only. Attempting to tension the chain when the chain brake nuts are tight can cause damage.

Use the screwdriver end of the chain adjustment tool (bar tool) to move the chain around the bar.

- If the chain does not rotate, it is too tight.
- If too loose, the chain will sag below the bar.

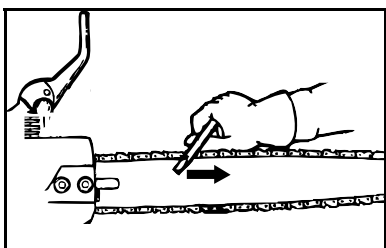

**Tensioning the chain**

**! WARNING**  
 A slack chain may jump off and cause serious or even fatal injury.

The more you use a chain the longer it becomes. It is therefore important to adjust the chain regularly to take up the slack.

Check the chain tension every time you use or refuel the chain saw.

**! WARNING**  
 A new saw chain has a running-in period during which you should check the tension more frequently.

Tension the chain as tightly as possible, but not so tight that you cannot pull it round freely by hand.

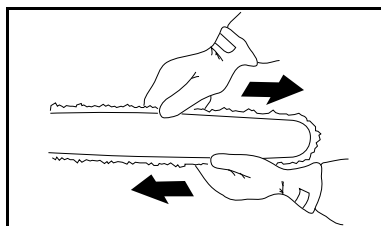

1. Loosen the bar nuts that hold the clutch cover and chain brake, using the combination spanner. Then tighten the nuts by hand as tight as you can.

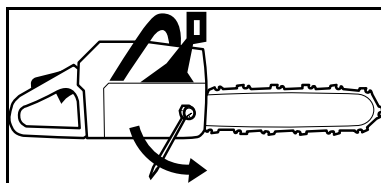

2. Raise the tip of the bar and stretch the chain by tightening the chain tensioning screw using the combination spanner. Tighten the chain until it not hang slack on the underside of the bar.

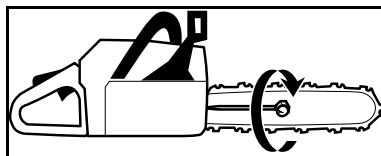

3. Use the combination spanner to tighten the bar nuts while lifting the tip of the bar at the same time. Check that you can pull the chain round freely by hand and that it is not slack on the bottom of the bar.

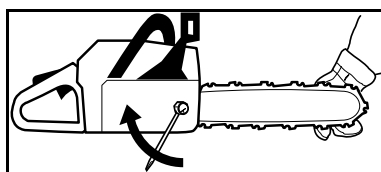

**i information**

The position of the chain tensioning screw varies from model to model.

## Checking chain lubrication

### **! WARNING**

Poor lubrication of cutting equipment may cause the chain to snap and lead to serious, even fatal injuries.

### **! WARNING**

Prolonged inhalation of exhaust gases from the engine, chain lubrication oil mist and/or saw dust can be unhealthy.

Check the chain lubrication each time you refuel.

Aim the tip of the saw at a light colored surface about 20 cm away. After 1 minute running at 3/4 throttle you should see a distinct line of oil on the light surface.

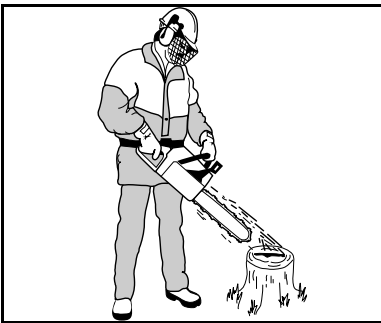

The chain oil flow can be adjusted by inserting a screwdriver in the hole at the bottom of the clutch side.

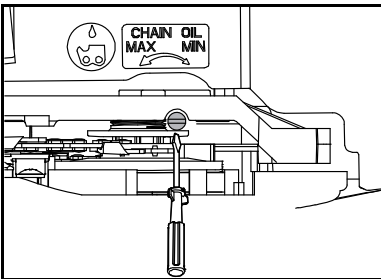

If the chain lubrication is not working:

1. Check that the oil channel in the bar is not obstructed. Clean if necessary.

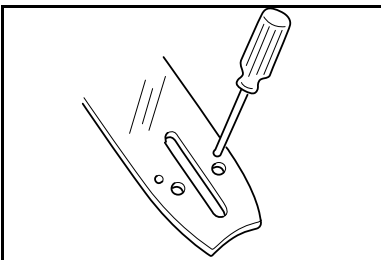

2. Check that the groove in the edge of the bar is clean. Clean if necessary.

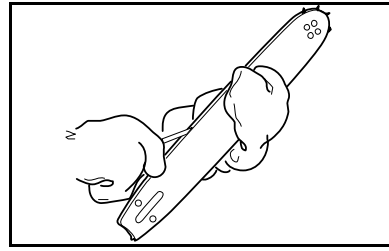

3. Check that oil port on the guide bar is not clogged. Clean if necessary.

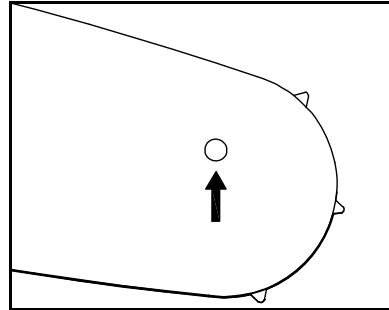

4. Check that the bar tip sprocket turns freely and that the lubricating hole in the tip is not blocked. Clean and lubricate if necessary.

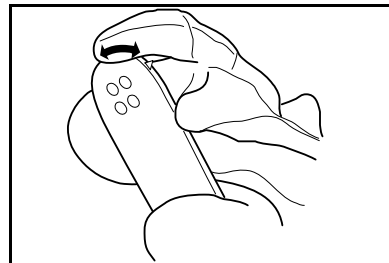

### **i information**

If the chain lubrication system is still not working after carrying out the above measures you should contact your service agent.

## Lubricating the bar tip sprocket

Lubricate the bar tip sprocket each time you refuel. Use the special grease gun and a good quality bearing grease.

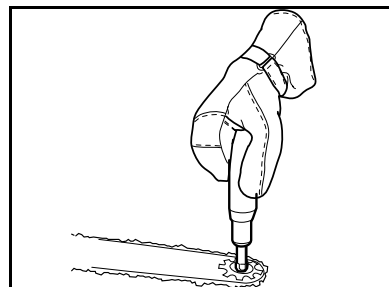

## Lubricating the clutch drum bearing

Between the engine drive shaft and the clutch drum is a needle bearing that must be lubricated daily. Use the specially designed grease gun and a good quality bearing grease.

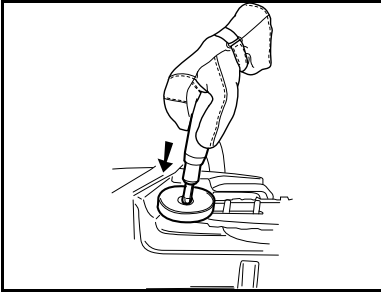

## Checking wear on saw chain

Check the saw chain daily for:

- Visible cracks in rivets and links.
- Whether the chain is stiff.
- Whether rivets and links are badly worn.

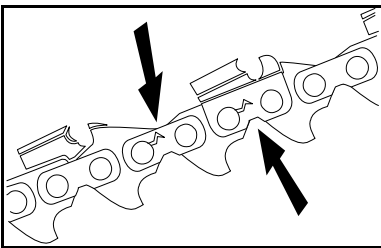

We recommend you compare the existing chain with a new chain to decide how badly it is worn.

When the length of the cutting teeth has worn down to only 4 mm (0.16 inch) the chain must be replaced.

## Checking wear on chain drive sprocket

The clutch drum is fitted with one of the following drive sprockets:

A=SPUR (integral drive sprocket)

B=RING (replaceable)

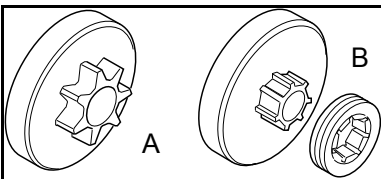

Regularly check the degree of wear on the drive sprocket. Replace if wear is excessive.

Replace the drive sprocket whenever you replace the chain.

## Checking the bar condition

Check the condition of bar regularly:

- Whether there are burrs on the edges of the bar (A), remove these with a file if necessary.
- Whether the groove in the bar has become badly worn (B), replace the bar if necessary.

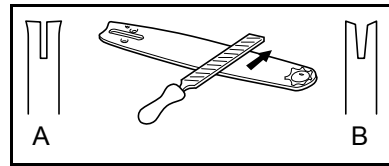

- Whether the tip of the bar is uneven or badly worn. If a hollow forms on one side of the bar tip this is due to a slack chain.

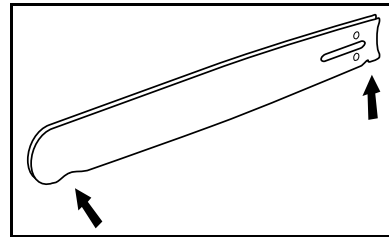

- To prolong the life of the bar you should turn it over daily.

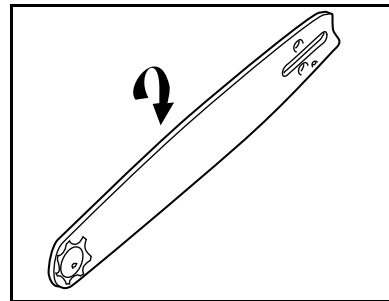

## Carburetor

### A. Basic information

#### ⚠ WARNING

The saw chain must not move at idle speed, otherwise serious personal injury may result. Periodic carburetor adjustment may be necessary to ensure saw chain does not move at idle speed.

#### ⓘ NOTICE

Carburetor adjustments, other than idle speed, must be performed by an authorized dealer or service center.

The carburetor governs the engine speed via the throttle. Air/ fuel are mixed in the carburetor. The air/fuel mixture is adjustable. To take advantage of the saw's maximum output the setting must be correct.

Adjusting the carburetor means the engine is adapted to local operating conditions, e.g. climate, altitude, petrol and the type of 2-stroke oil used.

The carburetor has three adjustment possibilities:

L = Low speed jet.

H = High speed jet.

T = Adjustment screw for idling.

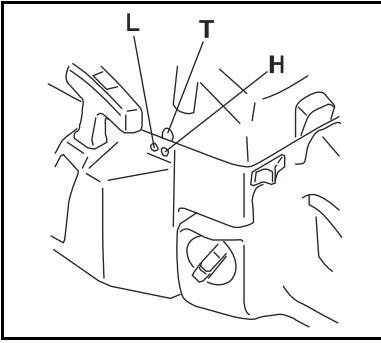

The fuel quantity required in relation to the air flow, provided by opening the throttle, is adjusted by the L and H-jets. If they are screwed clockwise the air/fuel ratio becomes leaner (less fuel), and if they are turned anti-clockwise the ratio becomes richer (more fuel). A leaner mixture gives a higher engine speed and a richer mixture give a lower engine speed.

The T screw regulates the idling speed. If the screw T is turned clockwise this gives a higher idling speed; anti-clockwise a lower idling speed.

### NOTICE

*If the chain rotates in the idling position, turn the idling speed screw counter-clockwise until the chain stops.*

### B. Adjustment of the idling speed T

Adjust the idling speed with the screw T. If it is necessary to re-adjust, first turn the idle speed adjusting screw T clockwise, until the chain starts to rotate. Then turn, counter-clockwise until the chain stops. A correctly adjusted idle speed setting occurs when the engine runs smoothly in every position. It should also be good margin to the rpm when the chain starts to rotate.

### WARNING

Contact your servicing dealer, if the idle speed setting cannot be adjusted so that the chain stops. Do not use the saw until it has been properly adjusted or repaired.

### C. Correctly adjusted carburetor

A correctly adjusted carburetor means that the saw accelerates without hesitation and the saw 4-cycles a little at max speed. Furthermore, the chain must not rotate at idling speed.

- A too lean adjusted low speed needle L may cause starting difficulties and bad acceleration.
- A too lean adjusted high speed needle H gives lower power=less capacity, bad acceleration and/or damage to the engine.
- A too rich adjustment of the two speed needles L and H gives acceleration problems or too low working speed.

### Starter device

### WARNING

When the recoil spring is assembled in the starter housing, it is in tensioned position and can when treated carelessly, pop out and cause injuries.

Always be careful, when changing the recoil spring or the starter cord. Always wear safety goggles for eye protection.

### A. Changing a broken or worn starter cord

1. Loosen the screws, that hold the starter device against the crankcase and remove the starter device.

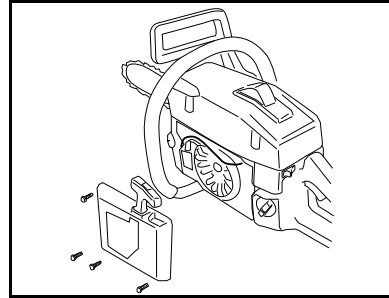

2. Pull out the cord approx. 30 cm and lift it up into the notch in the pulley. Zero-set the recoil spring by letting the pulley rotate slowly backwards. Undo the screw in the centre of the pulley and remove the pulley.

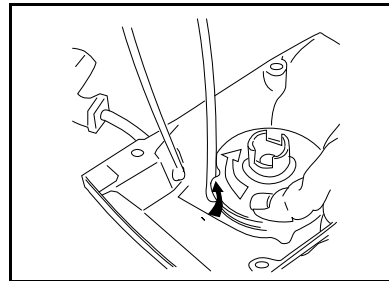

3. Insert and fasten a new starter cord in the pulley. Wind approx. 3 turns of the starter cord on to the pulley. Assemble the starter pulley against the recoil spring, so the end of the spring engages to the pulley. Fit the screw in the centre of the pulley. Carry the starter cord through the hole in the starter housing and the starter handle. Make a knot on the starter cord.

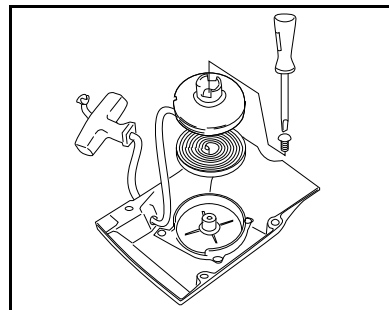

### B. Tensioning the recoil spring

Lift the starter cord up in the notch on the starter pulley, and turn the starter pulley 2 turns clockwise.

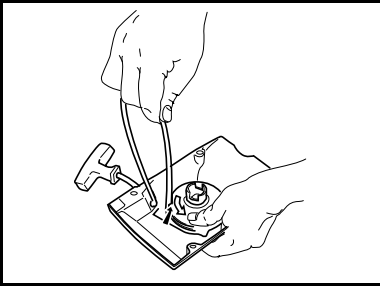

**! NOTICE**

*Check that the starter pulley can be turned at least half a turn, when the starter cord is entirely pulled out.*

**C. Changing the broken recoil spring**

1. Lift the starter pulley. (See, Changing a broken or worn starter cord). The recoil spring is disassembled from the starter device, with its inside facing down. Tap the starter lightly against a working bench or similar.

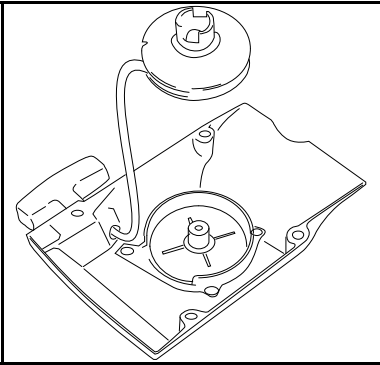

2. Put a new recoil spring in the right position. If the spring pops out when assembling, it should be mounted again, out and in towards the centre.

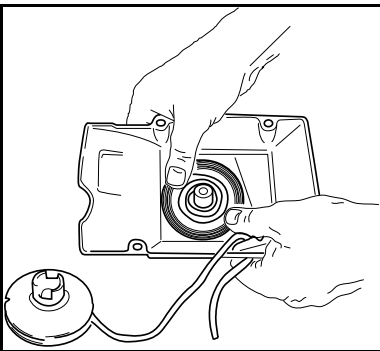

3. Lubricate the recoil spring with thin oil. Assemble the starter pulley, and tension the recoil spring.

**D. Starter device assembly**

1. Assemble the starter device, by pulling the starter cord out first, then place the starter against the crankcase. Then slowly release the starter cord so that the pulley engages with the pawls.

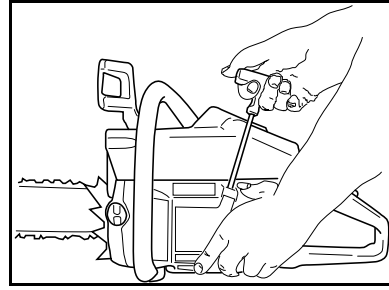

2. Assemble and tighten the screws, which hold the starter.

**Air filter**

The air filter must be regularly cleaned from dust and dirt in order to avoid:

- Carburetor malfunctions.
- Starting problems.
- Engine power reduction.
- Unnecessary wear on the engine parts.
- Abnormal fuel consumption.

Clean the air filter daily or more often if the air is exceptionally dusty in the working area.

1. Pull out the choke knob to "CLOSE" position. This prevents dirt from entering into the carburetor throat when the air filter is removed.
2. Brush accumulated dirt from air filter area.
3. Unscrew the air filter holder, and take out the air filter.

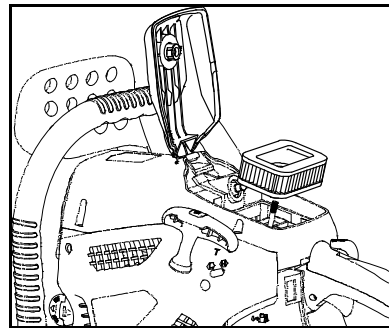

4. Dust on the cleaner surface can be removed by tapping a corner of the air filter against a hard surface. To clean dirt in the meshes, split the air filter into halves and brush in gasoline. When using compressed air, blow from the inside to the outside.
5. Replace air filter if it is damaged, fuel soaked, very dirty, or the rubber sealing edges are deformed.
6. Dry the air filter completely before re-installing.
7. Install air filter and cylinder cover. When reassembling, make sure that the filter is tight against the filter holder.

**! NOTICE**

*A damaged air filter must always be replaced.*

## Spark plug

The spark plug condition is influenced by:

- An incorrect carburetor setting.
- Wrong fuel mixture (too much oil in the gasoline).
- A dirty air filter.

These factors cause deposits on the spark plug electrodes, which may result in malfunction and starting difficulties. If the engine is low on power, difficult to start or runs poorly at idling speed, always check the spark plug first.

If the spark plug is dirty, clean it and check the electrode gap. Readjust if necessary. The correct electrode gap(A) is 0.35~0.5 mm.

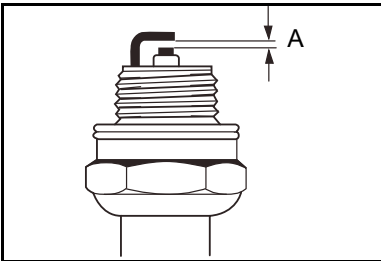

The spark plug should be replaced after about a month in operation or earlier if the electrodes are badly eroded.

1. Remove spark plug and check for fouling, worn and rounded center electrode.
2. Clean the plug or replace with a new one. Do not clean it with sand blast. Remaining sand will damage the engine.
3. According to Technical Specification, adjust spark plug gap by bending outer electrode.
4. Reinstall the spark plug, tighten it securely with a socket wrench.

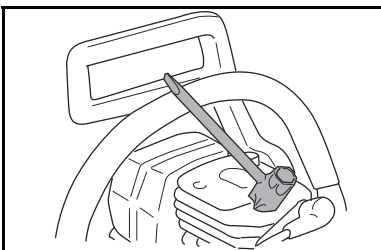

### NOTICE

Always use the recommended spark plug type. An incorrect spark plug can severely damage the piston/cylinder.

## Muffler

The muffler is designed in order to reduce the noise level and to direct the exhaust gases away from the operator. The exhaust gases are hot and can contain sparks, which may cause fire if directed against dry and combustible material.

Some mufflers (A) are equipped with a spark arrester mesh (B). If your chain saw has this type of muffler, you should clean the mesh at least once a week. This is done with a wire brush.

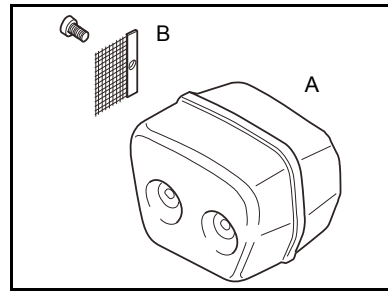

### NOTICE

The mesh must be replaced, if damaged. The saw will be overheated, if the screen is clogged. This results in damage on the cylinder and the piston. Never use a saw with a clogged or defective muffler.

## Adjusting the oil pump

The oil pump can be adjusted to give four (4) different oil flow rates.

To adjust the flow rate, first remove the chain, bar, clutch cover, centrifugal clutch and the clutch drum. Using a screwdriver, adjust the oil flow rate by turning the adjuster screw one way or the other. The projection on the screw should point towards the chosen setting. The diagram shows the setting for flow rate 2.

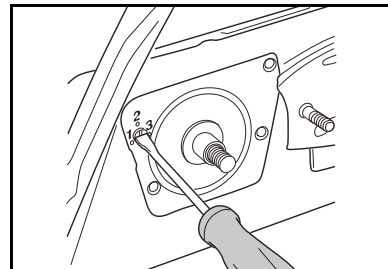

Recommended settings:

- 13" and 15" bars: Setting 2
- 18" bars and longer: Setting 3~4

### WARNING

Do not carry out this adjustment with the engine running!

## Needle bearing maintenance

The clutch drum is equipped with one of the following chain sprockets:

- Type A: Spur sprocket, the chain sprocket is welded on the drum).

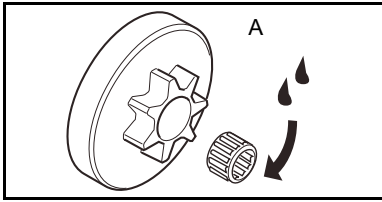

- Type B: Rim sprocket, the chain sprocket is exchangeable.

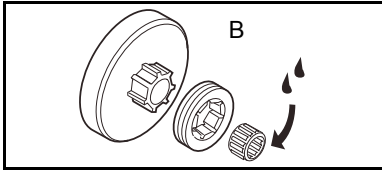

Both versions have built-in needle bearing at the drive shaft, which has to be greased regularly (once a week).

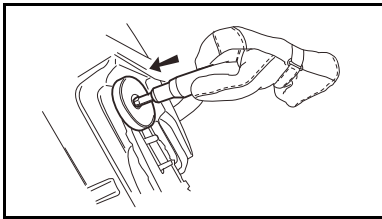

**NOTICE**  
Use only high quality bearing grease.

### Cooling system

To obtain the lowest possible running temperature the saw is equipped with a cooling system. The cooling system consists of:

1. Air intake on the starter unit.
2. Air guide plate.
3. Fan blades on the flywheel.
4. Cooling fins on the cylinder.
5. Cylinder cowling (supplies cold air over the cylinder).

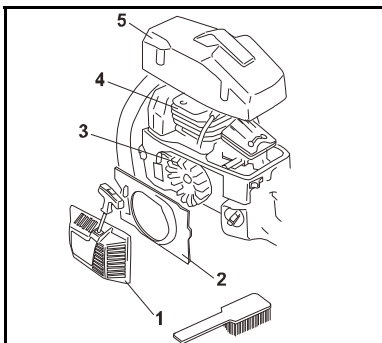

Clean the cooling system with a brush once a week, more often in demanding conditions. A dirty or blocked cooling system results in the saw overheating which causes damage to piston and cylinder.

### Daily maintenance

1. Check that all the components of the throttle control operate safely (i.e. throttle lock, throttle lever and start throttle lock).

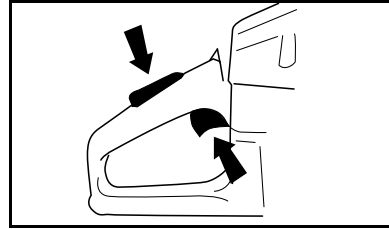

2. Clean the chain brake and check its function according to the instructions. Make sure that the chain catcher is undamaged. Otherwise replace it immediately.

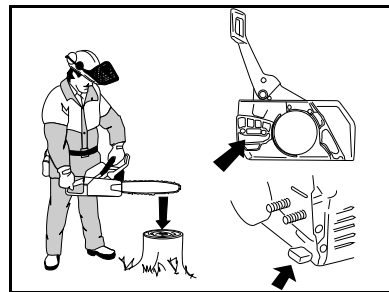

3. Clean or replace the air filter as necessary. Check for damage or holes.
4. The bar should be turned daily for more even wear. Check the lubrication hole in the bar, to be sure it is not clogged. Clean the bar groove, if the bar has a sprocket tip, this should be lubricated.

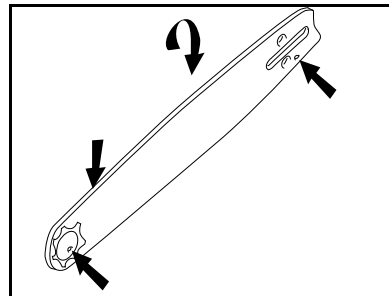

5. Check the function of the oiler to be sure the bar and chain receive proper lubrication.





6. Sharpen the chain and check its tension and condition. Check the drive sprocket for wear. Replace if necessary.

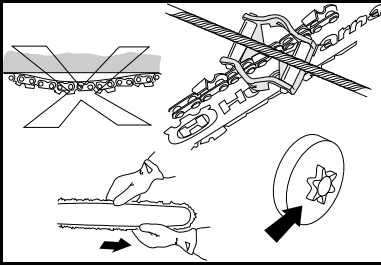

7. Check the starter and starter cord for wear or damage. Clean the air intake slots on the starter housing.

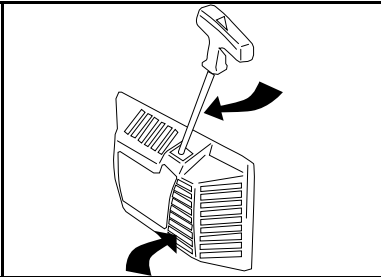

8. Check for any loose nuts and screws and retighten if necessary.

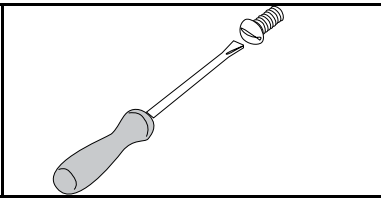

9. Test the stop switch to be sure it shuts off the engine.

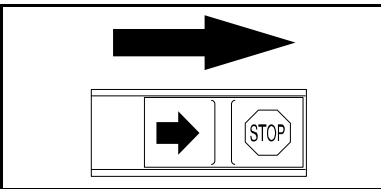

## Weekly maintenance

1. Check that the AV elements are not soft or torn.

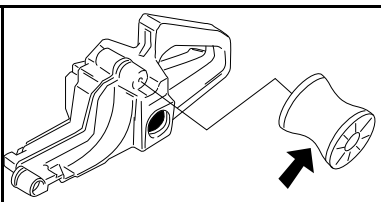

2. Lubricate the clutch drum bearing.

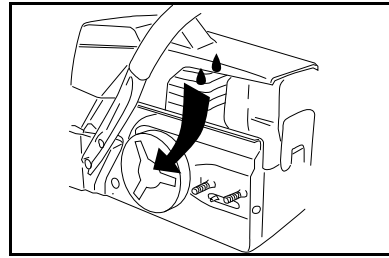

3. File off burrs, if any, on the sides of the bar.

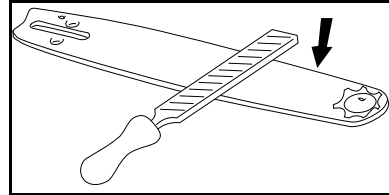

4. Clean the spark plug and check the gap. The correct gap (A) is 0.35~0.5mm.

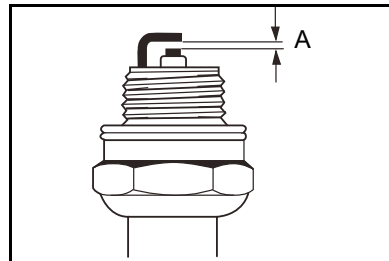

5. Check the starter and the recoil spring. Clean the fins on the flywheel.

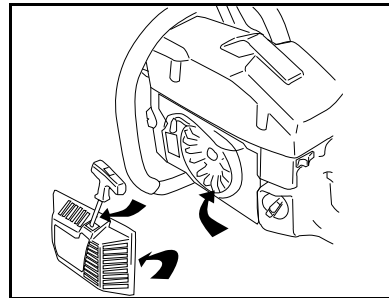

6. Clean the cooling fins on the cylinder.

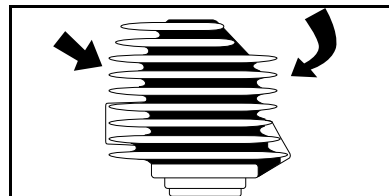

7. Clean or change the screen in the muffler.

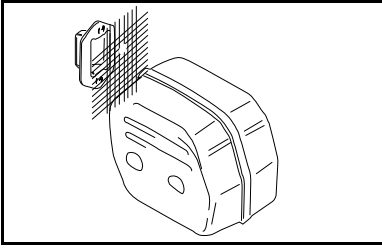

8. Clean the carburetor body and air box.

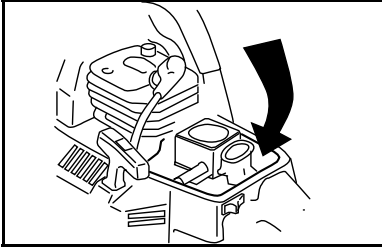

5. Flush the inside off the fuel tank with gasoline.

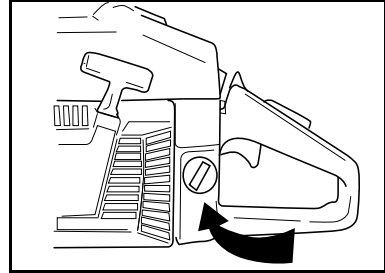

6. When the engine speed is not stable, check the oil filter. If the white filter element become grey or dark color, change the oil filter

### Monthly maintenance

1. Check the brake band on the chain brake for wear.

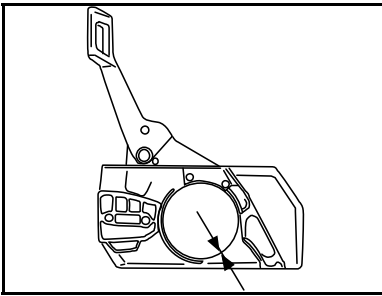

2. Check the clutch centre, clutch drum and clutch spring for wear.

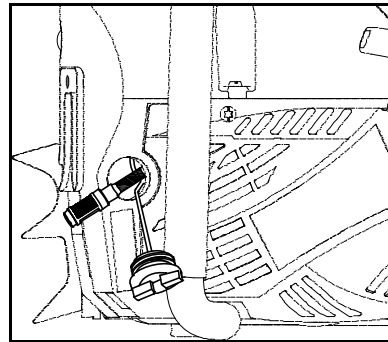

7. Flush the inside of the oil tank with gasoline.

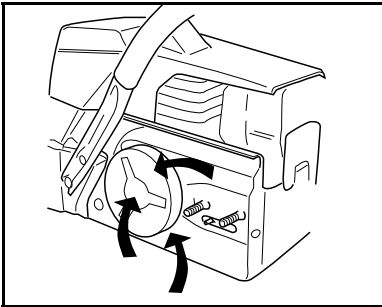

3. Clean the outside of the carburetor.

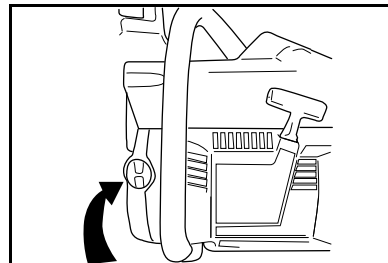

8. Check all cables and connections.

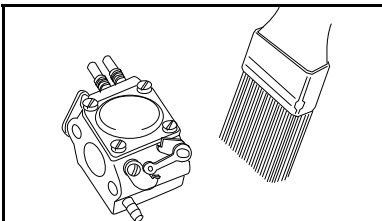

4. Check the fuel filter. Change if necessary.

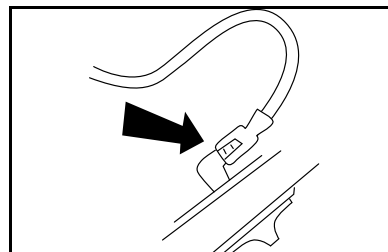

## Storage

### DANGER

Do not store the machine in enclosure where fuel fumes may accumulate or reach an open flame or spark, otherwise serious personal injury may result.

### WARNING

The muffler and surrounding covers become hot during operation. Always keep exhaust area clear of flammable debris during transportation or when storing, otherwise serious property damage or personal injury may result.

### WARNING

Saw chain are very sharp. Touching them may lead to severe personal injury. Avoid touching moving saw chain, and always wear gloves to protect hands.

Do not store your machine for periods of time 30 days or longer without performing protective storage maintenance which includes the following procedure:

1. Drain and clean fuel tank completely in a well ventilated outdoor area.
2. Dispose of fuel properly according to your local environmental regulations.
3. Run the engine until the carburetor is dry – this helps prevent the carburetor diaphragms sticking together.
4. Remove the saw chain and guide bar, clean them completely and spray with corrosion inhibiting oil.
5. Completely clean the machine, pay special attention to the cylinder fins and air filter.
6. Pour a small amount of clean motor oil into spark plug hole, pull starter and crank the engine until piston reaches TOP DEAD CENTER.
7. Install the spark plug, but do not connect ignition cable.
8. Store the machine in a dry, dust free place, out of the reach of children and other unauthorized person.

### NOTICE

*Always store and transport chain saws in a stable, horizontal position. Support gear case and saw chain to prevent excessive flexing, which may cause damage to these components. Always install saw chain cover when transporting or storing the machine.*

## Disposal

Observe all country-specific and local waste disposal rules and regulations.

CRAFTOP products must not be thrown in the garbage bin. Take the product, accessories and packaging to an approved disposal site for environment friendly recycling.

Contact your local authorized dealer or service center for the latest information on waste disposal.

## Troubleshooting guide

### DANGER

Fuel vapors are extremely flammable and may cause fire and/or explosion. Never test for ignition spark by grounding spark plug near cylinder plug hole, otherwise serious personal injury may result.

Problem		Cause		Solution
Engine cranks	<ul style="list-style-type: none"> <li>- but hard to start</li> <li>- does not start</li> </ul>			
Engine cranks	Fuel at carburetor	No fuel at carburetor	<ol style="list-style-type: none"> <li>1. Fuel filter clogged</li> <li>2. Fuel line clogged</li> <li>3. Carburetor</li> </ol>	<ol style="list-style-type: none"> <li>1. Clean or replace</li> <li>2. Clean</li> <li>3. Ask your local dealer</li> </ol>
	Fuel at cylinder	No fuel at cylinder	Carburetor	Ask your local dealer
		Muffler wet with fuel	Fuel mixture is too rich	<ol style="list-style-type: none"> <li>1. Open choke</li> <li>1. Clean/replace air filter</li> <li>2. Adjust carburetor</li> <li>3. Ask your local dealer</li> </ol>
	Spark at end of plug wire	No spark at end of plug wire	<ol style="list-style-type: none"> <li>1. Ignition switch off</li> <li>2. Electrical problem</li> </ol>	<ol style="list-style-type: none"> <li>1. Turn switch on</li> <li>2. Ask your local dealer</li> </ol>
	Spark at plug	No spark at plug	<ol style="list-style-type: none"> <li>1. Spark gap incorrect</li> <li>2. Covered with carbon</li> <li>3. Fouled with fuel</li> <li>4. Spark plug defective</li> </ol>	<ol style="list-style-type: none"> <li>1. Adjust gap to specification</li> <li>2. Clean or replace</li> <li>3. Clean or replace</li> <li>4. Replace plug</li> </ol>
Engine does not crank			Internal engine problem	Ask your local dealer
Engine runs	Dies or accelerates poorly		<ol style="list-style-type: none"> <li>1. Air filter dirty</li> <li>2. Fuel filter dirty</li> <li>3. Fuel vent blocked</li> <li>4. Spark plug</li> <li>5. Carburetor</li> <li>6. Cooling system blocked</li> <li>7. Exhaust port/spark arrestor screen blocked</li> </ol>	<ol style="list-style-type: none"> <li>1. Clean or replace</li> <li>2. Clean or replace</li> <li>3. Clean</li> <li>4. Clean and adjust/replace</li> <li>5. Adjust</li> <li>6. Clean</li> <li>7. Clean</li> </ol>
Engine will not start or will run only a few seconds after starting.			<ol style="list-style-type: none"> <li>1. Ignition switch off</li> <li>2. Engine flooded</li> <li>3. Fuel tank empty</li> <li>4. Spark plug not firing</li> <li>5. Fuel not reaching carburetor</li> </ol>	<ol style="list-style-type: none"> <li>1. Move ignition switch to ON</li> <li>2. Follow Start warm engine procedure</li> <li>3. Fill tank with correct fuel mixture</li> <li>4. Install new spark plug</li> <li>5. Check for dirty fuel filter; replace. Check for kinked or split fuel line; repair or replace.</li> </ol>
Engine will not idle properly.			<ol style="list-style-type: none"> <li>1. Carburetor requires adjustment.</li> <li>2. Crank shaft seals worn</li> </ol>	<ol style="list-style-type: none"> <li>1. See the section of carburetor adjustment.</li> <li>2. Contact an authorized dealer or service center.</li> </ol>
Engine will not accelerate, lacks power, or dies under a load.			<ol style="list-style-type: none"> <li>1. Air filter dirty.</li> <li>2. Spark plug fouled.</li> <li>3. Chain brake engaged.</li> <li>4. Carburetor requires adjustment.</li> </ol>	<ol style="list-style-type: none"> <li>1. Clean or replace air filter.</li> <li>2. Clean or replace plug and adjust the gap.</li> <li>3. Disengage chain brake.</li> <li>4. Contact an authorized</li> </ol>

		dealer or service center
Engine smokes excessively.	Too much oil mixed with gasoline.	Empty fuel tank and refill with correct fuel mixture.
Chain moves at idle speed.	<ol style="list-style-type: none"> <li>1. Idle speed requires adjustment.</li> <li>2. Clutch requires repair</li> </ol>	<ol style="list-style-type: none"> <li>1. See the section of carburetor adjustment.</li> <li>2. Contact an authorized dealer or service center.</li> </ol>

 **information**

*If your chain saw seems to need further service, please consult with your local authorized dealer or service center.*

**CRAFTOP**®

[WWW.CRAFTOP.COM](http://WWW.CRAFTOP.COM)